

Digikröm
DK 240 $\frac{1}{4}$ Meter
DK 242 Double $\frac{1}{4}$ Meter
DK 480 $\frac{1}{2}$ Meter
Monochromator / Spectrograph

User Manual

Document 1049461-g

March, 2009



Spectral Products

2659-A Pan American Frwy., NE Albuquerque, NM 87107 Tel (505) 343-9700 Fax (505) 343-9705
www.spectralproducts.com

About Spectral Products

Spectral Products is a world leader in optical instrumentation technology and products. Spectral Products builds on its rich heritage and extensive technical knowledge to offer a broad range of innovative solutions from components to systems and modules. Spectral Products is an industry leader in the design and manufacture of optical instruments including spectrometers, monochromators, spectrographs, spectrophotometers, detection systems, light sources as well as fiber optic cables and couplers.

Headquartered in Putnam, Connecticut, Spectral Products' focus on quality, value and service has created an innovative approach to manufacturing and design. With employees in Putnam, Connecticut, Albuquerque, New Mexico and Seoul, South Korea, Spectral Products continues the tradition of design innovation, high quality products and exceptional value.



Spectral Products

2659-A Pan American Frwy., NE Albuquerque, NM 87107 Tel (505) 343-9700 Fax (505) 343-9705
www.spectralproducts.com

1.1 Mission Statement.....	4
1.2 Warranty	4
1.3 Copyrights.....	5
3.1 Verify Shipping Contents	7
3.2 Hardware Connections.....	7
3.3 Monochromator Control	7
3.4 Software	8
4.1 DK240/DK480	9
4.2 DK242.....	9
4.3 Wavelength Accuracy.....	10
4.4 Resolution	10
4.5 Grating Drive Precision	10
4.6 Slits	10
7.1 Sources of error.....	22
7.2 Acceptance criteria.....	23
8.1 Command Summary	25
8.2 Remote Operation	34
8.3 Encoding/Decoding Data Bytes.....	37
8.4 Status Bytes.....	39
8.5 Novram Program.....	40
8.5.1 READ FROM NOVRAM.....	40
8.5.2 WRITE TO NOVRAM.....	40
8.6 RS-232 (Serial) Connection Diagram.....	41
8.7 GPIB(IEEE-488) Interface Option	43
9.1 Operation.....	45
10.1 Optical Diagram of DK240/480.....	62
10.2 Optical Diagram of DK242	63
11.1 Calibrating Zero with DK2401	64
11.2 Calibrating a Wavelength with DK2401.....	64
11.3 Slit Calibration	65
11.4 Calibrating Zero with DKDemo VB Software	65
11.5 Calibrating a Wavelength with DKDemo VB software	67
11.6 Slit Calibration Using DKDemo VB Software.....	68
11.7 DK242 Calibration.....	69



1 Introduction

1.1 Mission Statement

Our mission is to provide our customers with reliable products, on time, and at a fair price. We are continually striving to maintain the highest standards, by assuring defect-free products and by providing prompt and courteous customer service.

The staff at Spectral Products (**SP**)` will be happy to answer any questions about our products and our services. For immediate assistance, please contact Spectral Products directly at (505) 343-9700, by fax (505) 343-9705, or by e-mail at sales@spectralproducts.com

1.2 Warranty

- This product is warranted to be free of defects in materials and workmanship for one year from date of purchase.
- This manual and the software it describes are provided free of charge as a service to the customer. The software is intended to be used as a tool for development and as an example of one possible method of code implementation. It is not intended to be a “user application.”
- Any software associated with this product is provided “as is” with no warranty, expressed or implied. While it is Spectral Products’ intent to provide error-free development tools, no guarantee is made regarding either the accuracy or usefulness of this material.
- Failures or damages resulting from lack of operator attention to proper procedures, failure to follow operating instructions, unauthorized modifications, and natural disasters are not covered under this warranty.
- **SP** reserves the right, without prior or further notice, to make changes to any of its products described or referred to herein to improve reliability, function, or design.
- **SP** accepts no liability for incidental or consequential damages arising from the use of this software.
- **SP** does not recommend the use of its components or software products in life support applications wherein a malfunction or failure of the product may directly threaten life or result in injury.
- **SP** does not recommend the use of this product on the same power line as other equipment with high current draw requirements.
- **The Digikröm DK240/480 does not contain any user serviceable parts. Removing its cover, without explicit written permission from Spectral Products, will void any written or implicit warranty.**



1.3 Copyrights

Spectral Products maintains the copyright on this material, but grants the user rights to use or to modify the software described herein without obtaining Spectral Products' permission and without the requirement to reference Spectral Products as the source of the material.

Lab VIEW[®] is a registered trademark of National Instruments.

Windows[™], Microsoft[®] Visual Basic[™] and Microsoft[®] Quick Basic[™] are registered trademarks of Microsoft Corporation.



2. Product Overview

The Digikröm DK240/480 are $\frac{1}{4}$ and $\frac{1}{2}$ meter, Czerny-Turner type monochromator/spectrographs. Focal lengths are 240mm and 480mm respectively. The grating(s) of your Digikröm are controlled by a microprocessor-driven stepper motor, which is coupled to the grating table. Thus, there is no sine-bar drive mechanism in the Digikröm monochromators. This design permits a simple rugged mechanism, which is less likely to drift out of calibration during extensive use, and/or rough handling.

The Digikröm is controlled by a handheld controller, direct RS-232 computer control, or by using the optional GPIB (IEEE-488) interface. All necessary protocol and command functions are given in this manual.

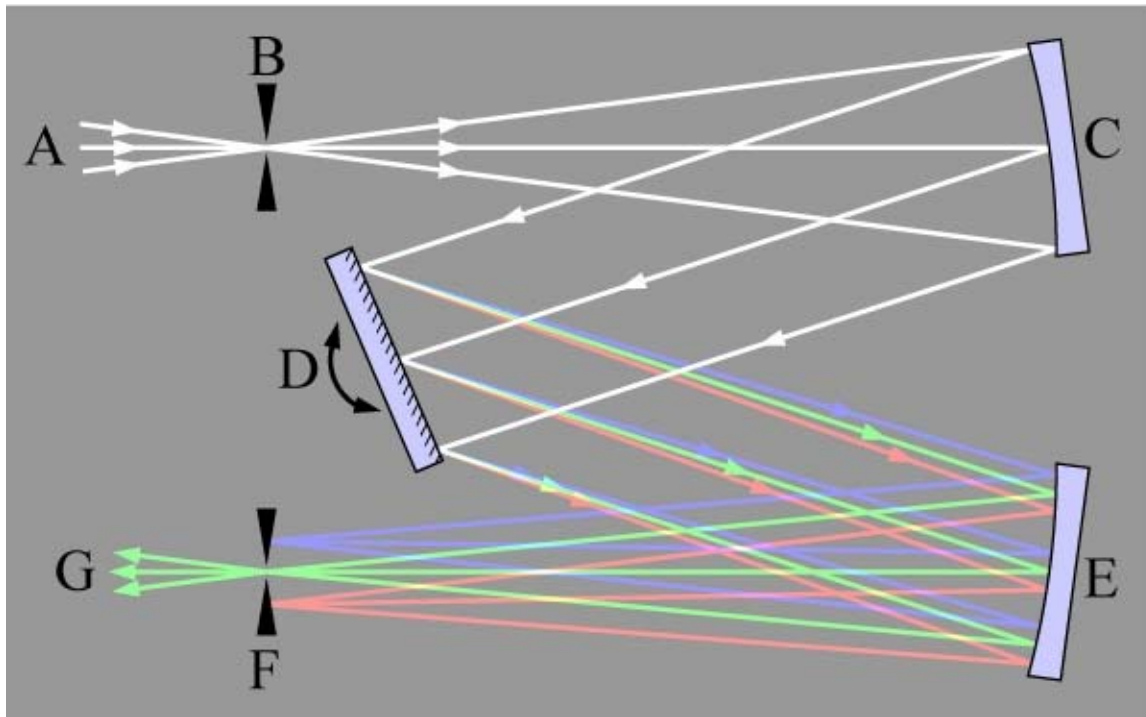

Basic Czerny-Turner monochromator design



Spectral Products

2659-A Pan American Frwy., NE Albuquerque, NM 87107 Tel (505) 343-9700 Fax (505) 343-9705
www.spectralproducts.com

3. Getting Started

3.1 Verify Shipping Contents

The Digikrom 240/480 monochromators do not require removal of any interior shipping restraints. **NOTE:** This equipment contains static sensitive devices. Handle equipment in a static safe environment until power can be supplied to the unit.

The following items are shipped with your order of a DK series monochromator:

- 1 DK240/480/242
- 1 DK24Vxx power supply
- 1 Serial communications cable
- 1 Demonstration CD software.
- 1 DK Utility CD containing test data, calibration data.

3.2 Hardware Connections

Power is supplied to the DK240/480 via the TPS65-0515DS power supply.

- Attach the power cord to the three-prong outlet on the back of the power pack.
- Attach the connector from the power supply to the monochromator.
- Plug the power cord into your wall or power strip outlet. The monochromator will reset in approx. 3 minutes and find home position.

3.3 Monochromator Control

- The monochromator can be controlled by an optional handheld controller or with a computer.
- To control the monochromator from a computer, connect the supplied serial interface (RS-232) cable, from the computer, directly to the monochromator 25 pin connector located at one end of the monochromator.
- To control the monochromator using the hand held control module, see control module instructions in chapter 3.2.



3.4 Software

DK240/480 Demonstration Software-Windows™

DK series monochromator demonstration software is written in Microsoft® Visual Basic™ 16 bit, Ver. 4.0 for Windows™ and will run on Windows™ 3.11, 95, 98, 2000, and NT 4.0. The demonstration software, along with instructions for operation, is found on the CD software disk. If you are interested in writing custom software that supports the DK240/480, we will be pleased to send this source code upon request. If you have any questions about the operation of your monochromator or if you have suggestions, please contact us. We appreciate your comments and suggestions.



3. Product Specifications

4.1 DK240/DK480

- **Wavelength Drive:** Worm and wheel with microprocessor control. Bi-directional.
- **Design:** Czerny-Turner, triple-grating turret.
- **Focal Length:** 240/480 mm.
- **F/#:** 3.9/7.8.
- **Gratings:** 68 x 68 mm ruled is standard. Holographic available.
- **Wavelength Precision:** 0.01 nm with 1200 g/mm grating.
- **Wavelength Accuracy:** ± 0.3 nm with 1200 g/mm grating.
- **Scan Speed:** 1 to 1200 nm/minute with 1200 g/mm grating.
- **Maximum Resolution:** 0.2/0.1 nm with 1200 g/mm grating.
- **Slits:** Computer controlled. Width – 10 to 3000 μ m. Height – 2 to 20 mm.
- **Software:** Demo control program with source is included. A Lab VIEW[®] Driver is available upon request.
- **Power:** UL listed 110/220 V power pack, meets or exceeds UL1950, CSA 1402C, and IEC 950.
- **Interface:** RS-232 standard.
- **Warranty:** One year from delivery date.
- CE marked.

4.2 DK242

- **Wavelength Drive:** Worm and wheel with microprocessor control. Bi-directional.
- **Design:** Czerny-Turner, triple-grating turret.
- **Focal Length:** 240 mm.
- **F/#:** 3.9.
- **Gratings:** 68 x 68 mm Ruled is standard. Holographic available.
- **Wavelength Precision:** 0.01 nm with 1200 g/mm grating.
- **Wavelength Accuracy:** ± 0.3 nm with 1200 g/mm grating.
- **Scan Speed:** 1 to 1200 nm/minute with 1200 g/mm grating.
- **Maximum Resolution:** 0.2 nm with 1200 g/mm grating.
- **Slits:** Computer controlled. Width – 10 to 3000 μ m. Height – 2 to 20 mm.
- **Software:** Demo control program with source is included. A Lab VIEW[®] Driver is available upon request.
- **Power:** UL listed 110/220 V power pack, meets or exceeds UL1950, CSA 1402C, and IEC 950.
- **Interface:** RS-232 standard.
- **Warranty:** One year from delivery date.
- CE marked.



4.3 Wavelength Accuracy

Grating (g/mm)	DK240/242	DK480
3600	.1nm	.1nm
2400	.2nm	.2nm
1200	.3nm	.3nm
600	.6nm	.6nm
300	1.2nm	1.2nm
150	2.4nm	2.4nm
75	4.8nm	4.8nm
50	7.2nm	7.2nm

4.4 Resolution

Grating (g/mm)	DK240	DK242	DK480
3600	.05nm	.05nm	.04nm
2400	.1nm	.1nm	.07nm
1200	.2nm	.15nm	.1nm
600	.4nm	.4nm	.2nm
300	.8nm	.8nm	.4nm
150	1.6nm	1.6nm	.8nm
75	3.2nm	3.2nm	1.6nm
50	4.8nm	4.8nm	2.4nm

4.5 Grating Drive Precision

Grating (g/mm)	Micro stepped
3600	.01nm/step
2400	.01nm/step
1200	.01nm/step
600	.02nm/step
300	.04nm/step
150	.08nm/step
75	.16nm/step
50	.24nm/step

4.6 Slits

Type	Increment	Minimum	Maximum
Unilateral	1 μ	10 μ	3000 μ
Bilateral	1 μ	10 μ	5000 μ

Slit aperture height is adjusted by removing the plate covering the slit with a 3/32" hex head wrench. Then loosen the aperture securing screw with a 3/64" hex head wrench, slide the aperture to the desired height, and retighten.

- **DO NOT FULLY REMOVE THE APERTURE RETAINING SCREW, OR THE APERTURE WILL FALL INTO THE MONOCHROMATOR BODY.**



5. Theory of Operation

The optics of monochromators are designed so that, for monochromatic light, an image of the entrance slit is formed at the exit slit. Scanning the monochromator rotates the grating and moves this image across the exit slit. If one were to measure the intensity of the light exiting the monochromator as this scanning occurs, one would see that a triangular intensity profile results. This is shown in Fig 2.1. Diffraction and other aberrations cause deviations from this ideal situation.

Because of the physics of diffraction gratings, entrance slit images are formed at different angles for different monochromatic wavelengths. Therefore, rotating the grating also selects a changing wavelength region. This is described by the grating equation.

$$l = \frac{2 * d * \text{COS}(\text{Æ}) * \text{SIN}(q)}{n}$$

Imagine a source that sends two monochromatic lines into a monochromator. If the wavelengths are sufficiently different, the two monochromatic slit images will not overlap at the exit slit. However, the finite width of the slits allows the possibility of overlap for some wavelength difference. That is, the slit width limits the ability to resolve two closely spaced wavelengths.

Wider monochromator entrance slits allow more light to enter into the instrument. Narrower slits allow for better resolution between wavelengths. This is one of the basic trade-offs in the use of monochromators.

The wavelength that is passed by the monochromator, lambda, is described by the grating equation that was presented earlier.

$$l \text{ [nm]} = \frac{2 * d * \text{COS}(\text{Æ}) * \text{SIN}(q)}{n}$$

or in wavenumbers

$$s \text{ [cm}^{-1}] = n * (0.5 / \text{COS}(\text{Æ})) * N * \text{CSC}(q)$$

where

- d — is the grating groove spacing in meters
- N — is the number of grooves per centimeter
- Æ — is the Ebert angle. This is a fixed angle determined by the positions of the grating, the collimating mirror, the camera mirror and is approximately 18 degrees for the DK240.
- q — is the angle of grating rotation measured from the point at which white light is specularly reflected through the instrument.
- (Note that » 70° is the maximum grating angle.)



- n — is the order of diffraction. Typically, for light incident normally to a grating, some of the light will be reflected (zero order), some will be diffracted to the right (+1 order), and some will be diffracted to the left (-1 order). Diffraction at greater angles also occurs, but is not significant (orders +2, -2, +3...). The DK240 grating drive provides a $D\theta$ of 7.5×10^{-3} degrees.

Because entrance slit images are formed at different angles for different monochromatic wavelengths, different wavelengths will be exiting the monochromator at different angles. The grating causes an angular dispersion as a function of wavelength and this angular dispersion is preserved at the exit slit.

In a single monochromator the angles at which light strikes the grating is independent of wavelength.

In the second half of a double monochromator, the angle at which the light strikes the grating depends on the wavelength. (The first grating has introduced angular dispersion as a function of wavelength.)

If the second grating rotates in the same direction as the first grating, then the angular dispersion of the second grating will add to that of the first grating. The dispersion is doubled. If the entrance, center and exit slits are approximately the same width, then it is the entrance and exit slits that limit the band pass. Because the dispersion at the center slit is half of that at the exit slit, the band pass of the center slit is twice that of the exit slit.

If the second grating rotates opposite to the first grating, then the angular dispersion of the second grating will subtract from that of the first grating. The net dispersion is zero. Now the entrance and center slits determine the band pass. Because the dispersion at the exit slit is zero, its width has no effect on the band pass.

Subtractive dispersion is useful in imaging applications and in pulse studies.

In trying to relay an image through a single monochromator, the image is distorted by the angular dispersion that exists at the exit slit. This angular dispersion is cancelled in the subtractive double.

In pulse analysis, a single monochromator will cause temporal broadening because of the unequal path lengths for light at the grating. In a subtractive double, these unequal path lengths are cancelled.

For users who wish further information we recommend the review article by Murty or Hutley's book on diffraction gratings. Specific questions about the DK series can be answered by the staff at SP.



6. Basics of Optical Spectrometers

NOTE TO READERS: The basics of optical spectrometers are familiar to most readers of this manual. However, terminology and interpretations of instrument characteristics vary somewhat and these basics are repeated here as they apply to

Spectral Products dispersive grating instruments come in two forms; monochromators that select one wavelength and spectrographs that output a range of wavelengths, generally for use with an array detector. Both share the same optical concept; they are one to one imaging systems in which one image of the entrance slit appears at the exit for each wavelength passed through the instrument.

Figure 1 shows the optical elements of a typical monochromator. Light enters through an entrance slit and is made into a nearly collimated beam by the collimating mirror. The light strikes a diffraction grating, which then disperses different wavelengths at different angles in the plane of incidence. The focusing mirror collects the light from the grating over a range of angles (and therefore from a range of wavelengths) and images the light to distinct positions near the exit slit. The physical position of the image depends on its angle on the camera mirror, and the angle depends upon its wavelength.

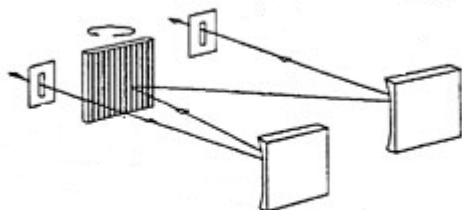
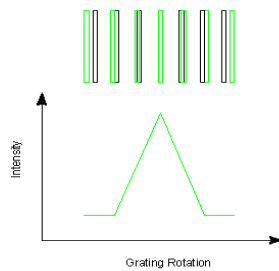

Figure 1: Typical monochromator.



During Monochromator scanning, the intensity of light that passes the exit slit waxes and wanes as the images of the entrance slit move across (see figure 2). The intensity at any time is the convolution of the intensity profile of the entrance slit image with the transmission profile of the exit slit.



As the grating rotates and the image of the entrance slit (green) approaches the exit slit (black), there is no light exiting the monochromator. Once the entrance slit image begins to overlap the exit slit opening, the output intensity increases until the maximum output is attained when the entrance slit image perfectly overlaps the exit opening. As the grating continues to rotate and the entrance slit image continues past the exit slit, intensity decreases until there is no light exiting when the entrance image has gone completely past the exit slit.

Figure 2
Formation of a spectral line

Figure 3 illustrates collection of a spectrum with a spectrograph and an array detector. In this case, the array detector elements see a signal that is proportional to the amount of the entrance slit image that falls on the element.

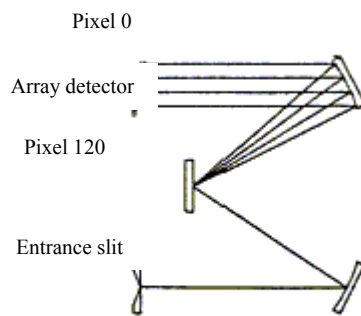
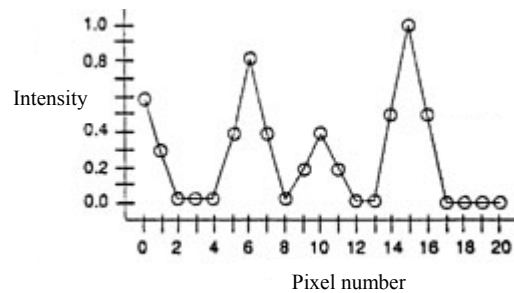

Figure 3: Array detection in a spectrograph and the resulting spectrum

Real sources are polychromatic, not monochromatic. For each wavelength present in the source an image of the entrance slit appears at slightly different position near the exit. The relationship between wavelength and position is referred to as the reciprocal linear dispersion (RLD) of the spectrometer – often referred to as just dispersion and expressed in units of nanometer per millimeter. The magnitude of the dispersion depends upon the wavelength, the focal length of the focusing mirror, and the grating. The intensity of polychromatic light passed by the monochromator is a complicated convolution of the intensity profile of the entrance slit image, the dispersion of the spectrometer, the spherical profile of the source, and the transmission profile of the exit slit.

Most optical spectrometers use diffraction gratings as the wavelength-dispersing element. The diffraction grating has a series of parallel grooves spaced at about the wavelength of light. Each groove diffracts the incident light, and interference between the diffracted light from each groove allows only one wavelength at each angle. Amazingly, gratings with as few as five grooves show the properties of diffraction gratings.

With the grooves of the grating perpendicular to the plane of incidence, light incident at angle i , is diffracted at an angle, r , for wavelength λ

$$n \cdot \lambda = d \cdot (\sin(i) + \sin(r))$$

Where d is the grating groove spacing and n is the order of the diffraction (see Figure 4).

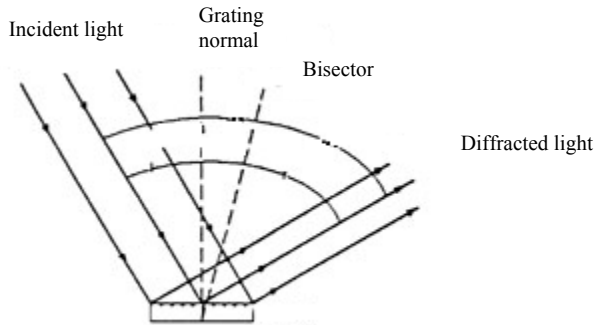

Figure 4: Diffraction by a grating. Light is incident at angle i . Light is diffracted at angle r . The sum of i and r is a constant (2ϕ) in a monochromator. $\theta = r - i$ is the angle of rotation from specular reflection.

The preceding discussion is a simplification, neglecting the optical aberration resulting from a less than perfect image of the entrance slit. Nevertheless, the model provides a good foundation for understanding the properties of monochromators and spectrographs as discussed below. For a more detailed treatment, see M.V.R.K.Murty, Theory and Principles of Monochromators, Spectrometers, and Spectrographs, Optical Engineering, Vol.13, No.1, Jan 1974.

▪ Properties of Spectrometers

The four important specifications in selecting a spectrometer are:

1. Wavelength resolution: the ability of the instrument to differentiate between different wavelength of light.
2. Through-put: the percentage of light that can be sent from a light source through the spectrometer.
3. Spectral purity: the ratio of the inband light passed by the spectrometer to the transmitted light that falls outside the selected spectral band.
4. Price: wavelength resolution, transmission efficiency, and spectral purity can vary dramatically between instruments as the size, type, quality, and design of optical systems differ.

The relative importance of these specifications depends upon the application. A tradeoff can be found between wavelength resolution and price by selecting an instrument with a focal length between 1/8 meter and 1/2 meter. Or, a double monochromator offers unbeatable spectral purity.

- **Wavelength resolution and its relatives**

The resolution of a spectrometer is classically defined as the wavelength separation ($\Delta\lambda$) between two ideal monochromatic spectral lines of equal intensity when their half maximum intensities overlap (since the spectral lines are monochromatic, their line shape comes from the instrument). This is approximately equivalent to saying that the resolution is the full width at half maximum (FWHM) measured for a single monochromatic line. Ideally, the resolution is limited by the number of illuminated grooves on a grating (N) providing the grating is uniformly illuminated:

$$(\lambda/\Delta\lambda) \leq N$$

In practice however, the resolution is typically limited by slit widths, dispersion, and optical aberrations in the system.

Other physical factors that may be external to the system can also impact resolution. Since three data points are needed to define a peak, a monochromator made to take large scanning steps will show a triangular peak (if it doesn't miss the peak altogether). The FWHM of this triangle will be wider than could be seen by taking finer steps. A similar effect limits the resolution of array-coupled spectrographs, where the minimum image size per data point is equivalent to a single pixel. At least three pixels are needed to define the monochromatic peak, so the FWHM becomes limited to value of 2-3 pixels widths multiplied by the RLD. Since there is no benefit to send multiple entrance slit images to the same pixel, the entrance slit should be set to a width no narrower than one pixel width.

- **Band pass (Monochromator)**

The FWHM is also called the band pass as it defines what band of wavelengths is passing through the spectrometer. Most often the term band pass is reserved for the FWHM at moderate to wide equal width slits. Optical aberrations, diffraction, scanning method, pixel width, slit height, uniformity of illumination and the like are negligible in this regime. The bandwidth then becomes the dispersion times the slit width.

- **Bandwidth (Spectrograph)**

Spectral Products uses the term Bandwidth to distinguish between the narrow band selected by the monochromator and the wide spectrum output by a spectrograph. When coupled to an array detector, the bandwidth designates the wavelength range thrown across the entire array.



- **Dispersion**

The reciprocal linear dispersion of a spectrometer can be found in the following (Leon Radziemski, Calculation of dispersion for a plane grating in a Czerny-Turner mount: a comment, Applied Optics. Vol 20, No. 11, 1 June 1981):

$$\frac{\Delta\lambda}{\Delta x} = \frac{d \cdot \cos(r)}{n \cdot f}$$

Where r is the diffraction angle, x is the lateral distance along the focal plane, n is the order, and f the focal length of the focusing mirror. Reciprocal linear dispersion is not a constant; it varies with wavelength and can exceed a factor of two over the useful spectral range.

- **Wavelength Precision, Reproducibility, and Accuracy**

Wavelength precision is the gradation on the scale that the spectrometer uses in determining wavelength. DK series monochromators and spectrographs employ a micro stepping grating drive that gives a wavelength precision of .01nm per step (averaged) with a 1200 l/mm grating.

Wavelength reproducibility is the ability of a spectrometer that has been set to a wavelength given to return to the original wavelength after the wavelength setting has been changed. This is a measure of the mechanics of the wavelength drive and the over all stability of the instrument.

Wavelength accuracy is the difference between the spectrometer's set wavelength and the true wavelength. It is not meaningful to apply a wavelength accuracy to a spectrograph because a wide band of wavelengths exists onto the detector array in a spectrograph. In monochromators, wavelength accuracy must be checked against known spectral line wavelengths. **SP** checks its monochromators at ten wavelengths across the 30% transmission spectral region of each grating.

- **Etendue, Spectral Energy Density, and Throughput**

The percentage of light that can be sent from a light source through a spectrometer would be a desirable measure of its throughput. Unfortunately, the properties of sources vary so much that this measure would not provide a useful standard. Instead, two separate specifications are useful; etendue, a measure of the degree of coupling that can be achieved, and transmission efficiency, a measure of how much of the input light exits the monochromator.

The etendue of an instrument is the product of an instrument's physical aperture (cm²) and its angular aperture (steradians). For a source of a given brightness [watts/(cm²*steradian)], the maximum power (watts) that can be coupled into an instrument is the product of the brightness and the etendue. This is true because the brightness of a source cannot be changed; changing the apparent emission angle changes the apparent size in inverse proportion. The brightness (a LaGrange Invariant) is unchanged. For a monochromator the etendue is:

$$E = S_w * S_h * W_g^2 / f^2$$

Where S_w = slit width



Sh = slit height
Wg = grating width
F = instrumental focal length

In a chain of optics or optical instruments, the component with the smallest etendue will determine the etendue of the system. For spectrometers it is useful to find the spectral energy density (watts/nanometer) that can be coupled. This can be found by dividing the etendue by the spectral bandwidth.

$$D = E / (Sw / (f * A))$$
$$D = (Sh / f) * Wg^2 * A$$

Where A is the angular dispersion of the grating.

The ratio of usable slit height to focal length is approximately constant across all monochromators. It is limited by aberrations. Therefore, the spectral energy density depends primarily on the grating width, and secondarily on the dispersion. To get the maximum throughput, use the widest, highest dispersion grating available!

Etendue defines the coupling between a light source and a spectrometer. Transmission efficiency describes the light loss within the spectrometer. The transmission efficiency becomes:

$$T = (Rm)^n * Rg$$

Where Rm is the reflectance of a single mirror; n is the number of mirrors; Rg is the diffraction efficiency of the grating.

Mirror reflectance is typically 0.92 for a protected aluminum mirror. In a four mirror system, about 70% is transmitted by the mirrors. **SP** offers custom broadband high reflectance coatings that can boost this efficiency to almost 95% in a four mirror system over about a wavelength octave.

Grating diffraction is quite complicated; it is both wavelength and polarization dependent. Grating diffraction efficiency for a ruled grating typically reaches 90% at the blaze wavelength, falling off to 20% at 0.6 * lambda blaze, and 1.5 * lambda blaze. Holographic gratings typically have a flatter 30% efficiency. Careful selection of gratings to match the spectral regions of interest will allow good transmission efficiency at any wavelength.



We can get a measure of total spectrometer throughput per nanometer by multiplying the spectral energy density by the transmission efficiency. The result is:

$$H = (Sh / f) * Wg^2 * A * (Rm)^n * Rg$$

- **The F/# Misconception**

F/# is the measure of the acceptance angle of an optical instrument, and is generally defined as the ratio of diameter to focal length. For years, F/# has been promoted as the measure of monochromator throughput. However, as previously discussed, grating size is the dominant factor in throughput. For example, a F/4 monochromator with a 30 mm² grating will have 44% more throughput than a F/2.5 monochromator with only a 25mm² grating. Similarly, a F/4 monochromator with a 68mm² grating will have 85% more throughput than a F/3 monochromator with a 50mm² grating. However, F/# is a useful concept in judging optimum coupling between spectrometers and sources or detectors. When F/#s are matched, the full aperture of the spectrometer will be utilized.

- **Stray Light**

Stray light is all out of band light transmitted by a spectrometer. Because the spectral profile of the source and the spectral sensitivity of the detector may enhance or under estimate the measured spectral purity, two distinct methods of stray light measurement have evolved.

The ASTM has published a filter method for measuring stray light in spectrometers. This method uses an incandescent lamp together with long and short pass blocking filters. This is useful for measuring the contribution of stray light originating far from the band pass region when using a continuum source.

Instruments SA introduced another method in the 1960s that is particularly relevant for laser spectroscopy. Their measure of stray light is the inverse ratio of light at the peak of a 632.8nm laser source to the light measured at 5 band passes from the peak. This method measures the contribution of stray light originating near the band pass region when using a line source. The following discussion reviews most of the sources of stray light in spectrometers.

- **Rediffracted Light**

Rediffracted light originates when a secondary order of diffracted light goes from the grating back to the collimating mirror. The light may then be reflected back to the grating where it is rediffracted. Because of the double bounce on the collimating mirror, the rediffracted light arrives at the exit slit unfocused. Typically, it will be 0.1% of the ordinary signal. (A discussion of rediffracted light is given in Mittledorf and Landon). Rediffracted light usually appears as a long wavelength spectral impurity in short wavelength light. Eliminating rediffracted light is a matter of design geometry.



- **Secondary Sources**

Secondary sources are sources of reflection within the spectrometer that direct stray light back into the main beam path. A typical example is a well intentioned but troublesome baffle placed nearly parallel to the beam path. Grazing incidence reflection off such a baffle will send light close enough to the correct beam path to end up as stray light at the exit. Stray light from secondary sources generally appears as a broad, flat-topped band in a spectral scan. Its intensity will be very sensitive to the illumination conditions. Blackening the baffle does not reduce the effect because of the strong reflectance of most materials at grazing incidence. In Spectral Products' spectrometers, baffles are treated as if they were mirrors. They are used to direct stray light out of the beam path.

- **Higher Order Diffraction**

Higher order diffraction is an inescapable source of stray light in grating based spectrometers. The grating equation $N * \lambda = d * (\sin(i) + \sin(r))$ allows not only first order diffraction of wavelength λ , but coincident diffraction of wavelengths $\lambda/2$, $\lambda/3$, $\lambda/4$... Depending upon the blaze wavelength of the grating, the efficiency for diffraction of these higher orders may actually be greater than the first order diffraction efficiency. The only way to eliminate these shorter wavelengths is with a filter. Fortunately, long pass filters are easily obtained. Spectral Products offers a series of filters that have been especially selected to suppress higher order diffraction.

- **Ghosts**

Ghosts are spurious spectral lines that originate in periodic irregularities in the diffraction grating. For a 1200 l/mm grating, for example, a .01% spurious modulation of the groove profile at 1000 l/mm would produce ghost lines. Those ghost lines would have a spacing of about $\lambda * (1 - 1/1.2)$ from each spectral line at wavelength λ . Ghosts were originally observed in spectrometers because they used ruled gratings manufactured on mechanical ruling machines that had intrinsic periodic errors in their mechanisms. Modern interferometrically controlled ruling machines produce gratings that are free of such errors. Holographic gratings can also exhibit ghosts, some with intensities exceeding conventionally ruled gratings. These holographic ghosts originate in extraneous reflections during the hologram exposure.

- **Scatter**

Scatter in a spectrometer is the primary source of diffuse background. Scatter does not originate in reflections from walls or other non-optical objects within the spectrometer. The probability of such light exiting the spectrometer is low. Scatter is diffuse reflection at the optical surfaces; the result of surface roughness, scratches, and digs. Scatter from the optical surfaces is important because it is most intense at low angles. This low angle scatter has a high probability of reaching the detector. Spectral Products has extensive experience in producing low scatter laser optics, with scratch and dig of 10/5 or better. All of this experience has been applied to the optics of Spectral Products' spectrum.



7. Sources of Errors in Spectrometers

Spectral Products' monochromators use a two-point calibration method, that is, the zero-order point and one wavelength. The zero-order point can be determined using virtually any light source, broadband or monochromatic, diffuse or coherent, since the grating is acting essentially as a mirror at this point. The slits are taken down to their minimum aperture (typically 10 μ m) and then the grating position is adjusted to produce maximum throughput. The "zero" command then stores this location into non-volatile RAM; the number stored is the number of motor steps from the device's physical home position (determined by location sensors on the grating turret and motor shaft) to the optimized optical zero-order point.

The second point can be calibrated at almost any arbitrary wavelength, usually chosen to be somewhere in the middle of the particular grating's spectral response. The monochromator compares its actual physical location with the ideal location for that wavelength (in terms of motor steps from zero) to produce the calibration number. This calibration number is not a count of motor steps or physical location, but a scaling factor used as a multiplier throughout the range of grating motion. Therefore, the monochromator takes the ideal number of motor steps (if the unit were optically and geometrically perfect) and scales it by the calibration factor. Each grating in a multiple grating monochromator has its own zero and calibration numbers, compensating for mechanical or optical variations as the gratings are changed.

7.1 Sources of error

The wavelength appearing at the exit slit of a Czerny-Turner monochromator (the design used in all Spectral Products monochromators) is given by the following equation.

$$\lambda = 2\cos(\phi/2)\sin(\theta)/(N*K)$$

where ϕ = Ebert angle

18.7° for a DK240

9.2° for a DK480

25.4° for a CM110

θ = Grating rotation from 0nm (deg)

N = Groove density (g/mm)

K = Diffraction order

Any of the above terms (with the exception of K, an integer) may be in error. The Ebert angle, that is the angle subtended at the grating surface by the central rays from the collimating and focusing mirrors, will vary from unit to unit. The mirrors may not be ground to precisely the same focal length or may be mounted slightly off center, either of which will shift K slightly. Similarly, the groove density of the grating may not be ideal. Gratings cut from the same master will be very close to one another, but may differ by some percentage from the stated value.

Both of the above values will affect the calibration of a given instrument, but once fixed, they remain constant for that particular unit and are accounted for by the calibration factor. By far the most critical source of error is the value of θ . Spectral Products monochromators use a worm/wheel grating drive driven by a step motor. The sources of error in such a system are multiple: non-



linearity of the worm wheel, non-linearity of the worm, step-angle errors in the motor, eccentricity of any of the shafts or assemblies, and any play in any part of the assembly. We attempt to ameliorate these errors through such means as:

1. Specifying ABEC 7-tolerance level in the bearings.
2. Specifying AGMA Q14 tolerance worms and worm wheels.
3. Specifying bores to 0.00025" tolerance, shaft run outs to .001".
4. Utilizing the highest quality step motors and driver electronics available.
5. Testing and run-in of all assemblies prior to integrating them into a monochromator, rejecting and/or rebuilding them as necessary.
6. Testing in the final unit, rejecting and replacing drives that do not meet criteria for accuracy and repeatability.

The above factors are all an attempt to achieve accuracy on the order of step-size resolution of each instrument: 0.00025° for the DK series. But such accuracy is not theoretically possible, even with the tightest of tolerances.

As an example, the DK series use a 64-pitch worm wheel, 180 tooth, and 2.8125" pitch diameter. AGMA Q14 tolerances give a tooth-to-tooth error tolerance of 0.00014", with a total composite tolerance of 0.00032". Therefore, the tooth-to-tooth angular error is given by:

$$\Delta\theta = \sin^{-1}(0.00014/(2.8125/2)) = 0.0057^\circ$$

Total composite error (i.e. from one random tooth to another) would be $0.01\sqrt{3}$ so; the worm wheel alone can contribute an absolute error of 50 micro steps in a standard DK. For a 1200g/mm grating around 600nm, that error would be about 0.35nm, and we are only considering errors introduced by the worm wheel itself. Experiments have demonstrated that the motor/shaft/worm assembly contributes errors much more important in determining the usability of a given grating drive. These errors tend to be pseudo-sinusoidal, cycling every 2° of grating motion, and at least as great in amplitude as the maximum wheel error.

7.2 Acceptance criteria

Monochromators are aligned and calibrated at Spectral Products by using a HeNe laser to level and align the optics, and to give an approximate calibration (assuming the laser frequency is within the grating's response range). A spectral line source such as an Ar or Hg lamp is then used to fine-tune the calibration, checking for repeatability and accuracy. Typically 10 known spectral lines falling within the 30% transmission range are examined for each grating. The calibration factor is determined by calibrating to the particular spectral line, which gives the best fit to the line set being examined. Automated scans then check for repeatability throughout the line set, recalibrating the unit as necessary. A technician, who writes the calibration into non-volatile RAM, then checks final calibration.

Acceptable errors for various grating groove densities are listed below.



Density (g/mm)	Accuracy (nm)	Repeatability (nm)
3600	±0.10	±0.03
2400	±0.15	±0.06
1200	±0.30	±0.10
600	±0.60	±0.20
300	±1.20	±0.40
150	±2.40	±0.80
75	±4.80	±1.60
50	±7.20	±2.40

Note that the acceptable error varies inversely with the groove density. This is because it is actually the same angular error of grating position. Further, these numbers are generalized to the middle of the grating range (about 30° from the zero order point). As can be seen from the grating equation, the output wavelength is not a linear function of the grating angle, therefore the same absolute error in grating position will produce a varying amount of wavelength error across the range of the grating.



8. Software Operation

8.1 Command Summary

The subscript _D indicates the decimal value of the byte is listed.

CLEAR

This command restores factory calibration values for the grating and slits.
This command also executes a reset, which returns the grating to home position.

To DK240/480: <25>_D
From DK240/480: <25>_D
From DK240/480: <Status Byte>
DK240/480 Action: Reset monochromator
From DK240/480: <24>_D

CSR

This command sets monochromator to Constant Spectral Resolution mode. The slit width will vary throughout a scan. This is useful, for example, where measurement of a constant interval of frequency is desired (spectral power distribution measurements).

To DK240/480: <28>_D
From DK240/480: <28>_D
*To DK240/480: <High Byte> <Low Byte>
From DK240/480: <Status Byte>
DK240/480 Action: Set mono to CSR mode
From DK240/480: <24>_D

*Band pass value = HighByte*256 + Low Byte (in hundredth's of nanometers)
See Appendix F, page 36, Constant Spectral Resolution

ECHO

The ECHO command is used to verify communications with the DK240/480.

To DK240/480: <27>_D
From DK240/480: <27>_D
DK240/480 Action: No action

GCAL

This command allows recalibration of the monochromator positioning scale factor and should be used immediately after using the ZERO command (see page 15). The monochromator should be set to the peak of a known spectral line, then the position of that line is input using the CALIBRATE command.

CAUTION: Use of this command will erase factory settings.



To DK240/480: <18> D
 From DK240/480:<18> D
 To DK240/480: <High Byte> <Mid Byte> <Low Byte>
 DK240/480 Action: If $65536 * \text{<High Byte>} + 256 * \text{<Mid Byte>} + \text{<Low Byte>}$ (in hundredths of nm) is a valid position; then the scale factor used in determining position will be recalibrated to make the current position agree with the input position. The grating will return to home after completion.
 From DK240/480:<Status Byte>
 From DK240/480:<24> D

GOTO

This command moves the monochromator to a selected position. Valid values of position are grating dependent and are described in Appendix C.

To DK240/480: <16> D
 From DK240/480:<16> D
 To DK240/480: <High Byte> <Mid Byte> <Low Byte>
 DK240/480 Action: If valid, grating will move to $65536 * \text{<High Byte>} + 256 * \text{<Mid Byte>} + \text{<Low Byte>}$ (in hundredths of nm)
 From DK240/480:<Status Byte>
 From DK240/480:<24> D

For example, the command to instruct the monochromator to **GOTO** the wavelength 250 nm could be sent as the 4 bytes <16> D <0> D <97> D <168> D (units are in hundredths of nm). Here, <16> D specifies the **GOTO** command while <0> D <97> D <168> D specifies the destination of 25000(in hundredths of nm).

GRTID?

Returns the 6 byte current grating ruling identifier.

To DK240/480: <19> D
 From DK240/480:<19> D
 From DK240/480:<Byte 1><Byte 2><Byte 3><Byte 4><Byte 5><Byte 6>
 1 = number of gratings installed in the monochromator (1-3)
 2 = number of grating currently in use (1-3)
 3 = high byte of current grating ruling (g/mm)
 4 = low byte of current grating ruling (g/mm)
 5 = high byte of current grating blaze wavelength (nm)
 6 = low byte of current grating blaze wavelength (nm)
 From DK240/480: <Status Byte>
 DK240/480 Action: No action
 From DK240/480:<24> D



GRTSEL

This command changes gratings , if additional gratings installed..

To DK240/480: <26>_D

From DK240/480:<26>_D

To DK240/480: <One Byte> (1, 2, or 3 depending on gratings installed)

From DK240/480:<Status Byte>

DK240/480 Action: If valid, slews to new grating and automatically resets..

From DK240/480:<24>_D

RESET

This command returns the grating to home position.

To DK240/480: <255>_D <255>_D <255>_D

DK240/480 Action: Grating will return to home position

SLIT RESET

This command resets one or all gratings to home position.

To DK240/480: <43>_D

From DK240/480:<43>_D

To DK240/480: <Slit Byte>

0: All slits

1: Entrance slit

2: Exit slit

3: Middle slit (DK242 only)

From DK240/480:<Status Byte>

DK240/480 Action: One or all slits will return to home position.

From DK240/480:<24>_D

SCAN

This command scans the monochromator between the present position and a alternate specified wavelength, at a rate determined by the SPEED command. Valid values of position are grating dependent.

To DK240/480: <12>_D

From DK240/480:<12>_D

To DK240/480: <High Byte> <Mid Byte> <Low Byte>

From DK240/480:<Status Byte>

DK240/480 Action: Scans the grating to the desired wavelength

From DK240/480:<24>_D



SCAN UP

Scans (faster than slewing) the grating towards the longer wavelength until the DK receives a 24 or reaches the limit of the grating operation.

To DK240/480: <9>_D
From DK240/480: <9>_D
DK240/480 Action: Slews until 24 received or limit is reached.
To DK240/480: <24>_D
From DK240/480: <Status Byte>
From DK240/480: <24>_D

SCAN DOWN

Scans (faster than slewing) the grating towards the shorter wavelength until the DK receives a 24 or reaches the limit of the grating operation.

To DK240/480: <3>_D
From DK240/480: <3>_D
DK240/480 Action: Slews until 24 received or limit is reached.
To DK240/480: <24>_D
From DK240/480: <Status Byte>
From DK240/480: <24>_D

SERIAL?

Returns the 5 digit serial number of the monochromator.

To DK240/480: <33>_D
From DK240/480: <33>_D
<1st Digit><2nd Digit><3rd Digit><4th Digit><5th Digit>
From DK240/480: <Status Byte>
DK240/480 Action: No action.
From DK240/480: <24>

SLEW UP

Slews the grating towards the longer wavelength until the DK receives a 24 or reaches the limit of the grating operation.

To DK240/480: <8>_D
From DK240/480: <8>_D
DK240/480 Action: Slews until 24 received or limit is reached.
To DK240/480: <24>_D
From DK240/480: <Status Byte>
From DK240/480: <24>_D



SLEW DOWN

Slews the grating towards the shorter wavelength until the DK receives a 24 or reaches the limit of the grating operation.

To DK240/480: <2>_D

From DK240/480:<2>_D

DK240/480 Action: Slews until 24 received or limit is reached.

To DK240/480: <24>_D

From DK240/480:<Status Byte>

From DK240/480:<24>_D

SLIT?

Returns the current four byte (six byte for DK242) slit width. First two bytes are high and low byte of the entrance slit width in microns. Second two bytes are the high and low byte of the exit slit width. For DK242, the last two bytes are for middle slit width.

To DK240/480: <30>_D

From DK240/480:<30>_D

From DK240/480:<4 or 6 Bytes><Status Byte>

DK240/480 Action: No action.

From DK240/480:<24>_D

SLTADJ

Adjusts all slits to a given width.

To DK240/480: <14>_D

From DK240/480:<14>_D

To DK240/480: <High Byte> <Low Byte>

From DK240/480:<Status byte>

DK240/480 Action: If valid, adjusts all slits to the new width.

From DK240/480:<24>_D

S1ADJ

Adjusts entrance slit to a given width.

To DK240/480: <31>_D

From DK240/480:<31>_D

To DK240/480: <High Byte> <Low Byte>

From DK240/480:<Status byte>

DK240/480 Action: If valid, adjusts the entrance slit.

From DK240/480:<24>_D



S2ADJ

Adjusts exit slit to a given width.

To DK240/480: <32>_D
From DK240/480: <32>_D
To DK240/480: <High Byte> <Low Byte>
From DK240/480: <Status byte>
DK240/480 Action: If valid, adjusts the exit slit.
From DK240/480: <24>_D

S3ADJ (DK242 Only)

Adjusts middle slit to a given width.

To DK240/480: <34>_D
From DK240/480: <34>_D
To DK240/480: <High Byte> <Low Byte>
From DK240/480: <Status byte>
DK240/480 Action: If valid, adjusts the middle slit.
From DK240/480: <24>_D

S1CAL

Allows for entrance slit calibration. Uses the same procedure as GCAL but with a two byte slit width specifier.

To DK240/480: <22>_D
From DK240/480: <22>_D
To DK240/480: <High Byte> <Low Byte>
From DK240/480: <Status byte>
DK240/480 Action: No immediate action.
From DK240/480: <24>_D

S2CAL

Allows for exit slit calibration. Uses the same procedure as GCAL but with a two byte slit width specifier.

To DK240/480: <23>_D
From DK240/480: <23>_D
To DK240/480: <High Byte> <Low Byte>
From DK240/480: <Status byte>
DK240/480 Action: No immediate action.
From DK240/480: <24>_D



S3CAL (DK242 only)

Allows for middle slit calibration. Uses the same procedure as GCAL but with a two byte slit width specifier.

To DK240/480: <35>_D
From DK240/480: <35>_D
To DK240/480: <High Byte> <Low Byte>
From DK240/480: <Status byte>
DK240/480 Action: No immediate action.
From DK240/480: <24>_D

SPEED

Selects the speed at which the monochromator may scan.

To DK240/480: <13>_D
From DK240/480: <13>_D
To DK240/480: <High Byte> <Low Byte>
From DK240/480: <Status byte>
DK240/480 Action: No immediate action. If a valid value (in nm/min) is selected, the SCAN command will thereafter cause the monochromator to move at approximately a speed value of (256 * <High Byte> + <Low Byte>)
From DK240/480: <24>_D

Relevant scan speeds (nm/minute):

If grating grooves are greater than or equal to 1200 g/mm, then the valid values for scan speeds will be from 1 to 600

If grating grooves are less than 1200 g/mm, then the valid values for scan speeds will be: (integer numbers from 1 to 600) x 1200/current grating groove. For example, with a 600-groove grating, valid values are: 2, 4, 8, ...1200.

Speed will be an integer number and is truncated after the calculation.

SSPEED?

Returns the current scan speed.

To DK240/480: <21>_D
From DK240/480: <21>_D
From DK240/480: <High Byte> <Low Byte>
From DK240/480: <Status byte>
DK240/480 Action: No immediate action.
From DK240/480: <24>_D



STEP DOWN

Moves the grating one step toward UV.

To DK240/480: <1>_D

From DK240/480: <1>_D

From DK240/480: <Status byte>

DK240/480 Action: If valid, moves the grating to a shorter wavelength in 1 motor step

From DK240/480: <24>_D

STEP UP

Moves the grating one step toward IR.

To DK240/480: <7>_D

From DK240/480: <7>_D

From DK240/480: <Status byte>

DK240/480 Action: If valid, moves the grating to a longer wavelength in 1 motor step

From DK240/480: <24>_D

TEST

Performs automatic self diagnosis.

To DK240/480: <17>_D

From DK240/480: <17>_D

From DK240/480: <Status byte>

DK240/480 Action: Mono initiates self diagnostic routine and will reset after sending <24>

From DK240/480: <24>_D

WAVE?

Returns the 3 byte current wavelength setting.

To DK240/480: <29>_D

From DK240/480: <29>_D

From DK240/480: <High Byte> <Mid Byte> <Low Byte>

From DK240/480: <Status byte>

DK240/480 Action: The current wavelength is: $65536 * \text{<High Byte>} + 256 * \text{<Mid Byte>} + \text{<Low Byte>}$ (in hundredths of nm)

From DK240/480: <24>_D



ZERO

This command sets the current wavelength to 0.00nm.

CAUTION: Use of this command will erase factory settings.

To DK240/480: <52>_D

From DK240/480: <52>_D

To DK240/480: *<One byte>_D

DK240/480 Action: The current zero offset values of the gratings are saved as the zero order position and sets the current position to 0.00 nm.

From DK240/480: <Status Byte>

From DK240/480: <24>_D

*<One Byte> For the DK240/480, the <one byte> is always 1, for the DK242 the <one byte> can be 1 or 2.



8.2 Remote Operation

The Digikröm 240/480 can be controlled by any remote computer that has an RS-232 serial communications port. Total control over the grating table and continuously variable slits can be achieved through a simple protocol. The RS232 connection requires a cable with a DB25-M subminiature connector (to connect to the monochromator) and a computer communications port connector at the other end, as appropriate for the user. Spectral Products offers a DK24AT, DK24PS, DK24MA and DK24IC cable for connecting to AT, PS2, MAC style computers and GPIB, respectively.

Pin Assignments for the Female DB-25 Connector at Ends of DK240/480

Pin	NAME	FUNCTION
1	GND	Chassis Ground
2	TxD	Data in (from computer to DK)
3	TxD	Data out (from DK to computer)
4	RTS	Clear to Send (output from host to DK)
5	CTS	Request to Send (output from DK to host)
6	DTR	Data Terminal Ready(output from DK to host)
7	GND	Signal Ground (common with chassis ground)
8-24	-	Not used
25	+5v	Receive current loop return

The pin assignments above are mapped one-to-one between the cable connection of a Digikröm and an IBM-AT style serial communications port.

The Digikröm emulates data communication equipment (DCE) when communicating with a remote computer. No crossing of data or handshake lines are necessary. The request to send/clear lines are used for handshake protocol of control communications. The Digikröm DK240/480 is factory configured and the character length; number of stop bits and parity cannot be changed. Its signal levels and format are the same as those that are specified for the RS-232.

The computer must be set to the Digikröm DK240/480 data type and baud rate

Character length: 8 bits
Baud rate: 9600 bits/sec
Stop bits: 1
Parity: None



Command	Byte (Decimal)	Description
Clear	<25>	Returns grating and slits to original factory calibration.
CSR	<28>	Adjusts the entrance and exit slits to the CSR value and sets the mono to the CSR mode.
Echo	<27>	Remote handshake byte, <27> = yes.
Gcal	<18>	This command prompts the user to “Enter the Calibration value” in the current units. <i>Changes made using this command will erase the values preset at the factory.</i>
Goto	<16>	This command allows the user to enter a new wavelength. Press the “Enter” key to complete this command.
Grtid?	<19>	Returns the current grating ruling identifier.
Grtsel	<26>	Changes grating if additional gratings are installed.
Reset	<255>	This command returns the grating to the home position.
Scan	<12>	This command allows the user to enter the wavelength.
Scan Up	<9>	Scans (faster than slewing) the grating towards the longer wavelength until the DK receives a 24 or reaches the limit of the grating operation.
Scan Down	<3>	Scans (faster than slewing) the grating towards the shorter wavelength until the DK receives a 24 or reaches the limit of the grating operation.
Serial?	<33>	Returns the serial number of the monochromator.
Slew Up	<8>	Slews the grating towards the longer wavelength until the DK receives a 24 or reaches the limit of the grating operation.
Slew Down	<2>	Slews the grating towards the shorter wavelength until the DK receives a 24 or reaches the limit of the grating operation.
Slit Reset	<43>	This command resets one or all slits.
Slit?	<30>	Returns the current slit width.
Sltdaj	<14>	Adjusts slits to a given width.
Speed	<13>	Sets the scan rate at which the grating rotates during Scan operation.
Sspeed?	<21>	Returns the current scan speed.
Step down	<1>	Steps the grating motor one step towards UV.
Step up	<7>	Steps the grating one step toward IR.
S1adj	<31>	Adjusts entrance slit only.
S2adj	<32>	Adjusts the exit slit only.
S3adj	<34>	Adjusts the middle slit on DK242 only.
S1cal	<22>	Allows for entrance slit calibration. <i>Changes made using this command will erase the values preset at the factory.</i>



S2cal	<23>	Allows for exit slit calibration. <i>Changes made using this command will erase the values preset at the factory.</i>
S3cal	<35>	Allows for middle slit calibration on DK242 only. <i>Changes made using this command will erase the values preset at the factory.</i>
Wave?	<29>	Returns the current wavelength setting.
Zero	<52>	Sets the current wavelength to 0.00nm. <i>Changes made using this command will erase the values preset at the factory.</i>

The Cancel byte, <24> (sometimes preceded by a status byte) terminates operation of the Digikröm. This does not apply to the Echo and Reset commands. A status byte is used to indicate errors or status information.



8.3 Encoding/Decoding Data Bytes

Many computer-based commands (RS-232) both send and receive information in the form of multi-byte specifiers. For a number given in decimal form, such as base 10, to be sent to the monochromator, the number must first be broken down into hexadecimal bytes (8 bits). Then, each byte is converted into a decimal value. This decimal value is transmitted as a ASCII character to the communication device. Then, the monochromator translates the characters into the form necessary to perform the operation. Conversely, the monochromator sends the data back in decimal characters. Each is a byte long, and the computer application must convert these separate bytes back to a useful decimal value.

- ENCODING DATA BYTES

The desired command is **GOTO** 100 nm.

The **GOTO** command in RS-232 is specified as:

<16><HIBYTE><MIDBYTE><LOWBYTE>

Where the current UNITS selected determine the units for the two-byte specifier. For this example, the units are in Angstroms.

Step 1: Convert the desired specifier to proper units.
100 nm = 10000 hundredths of nm

NOTE: The following steps will be shown two ways: **(A)** with conversions performed by a unspecified algorithm, for example, using a calculator with decimal-hex conversion capability, and **(B)** using a numeric algorithm that is more suitable for computers.

- **Method A:**

Step 2: Convert to Hexadecimal
1000(base 10) = 2710(base 16)

Step 3: Break the hex value into three bytes
2710(base 16) => 00 | 27 | 10
Hi Mid Lo

Step 4: Convert each byte to its decimal equivalent
Hi byte: 00(base 16) => 00(base 10)
Midbyte: 27(base 16) => 39(base 10)
Lowbyte: 10(base 16) => 16(base 10)

Step 5: Send the command. The specifiers are 0, 39 and 16.

- **Method B:**

Note: All the following numbers are given in decimals.

Step 2: Divide by 65536 and round down to the nearest **whole** number.
EX: 1000 / 65536 = 0.01526 rounds to 0 = Hi byte



Step 3: Calculate middle byte
EX: $10000 - (65536 \times \text{HiByte}) = 10000 - 0 = 10000$
 $10000/256=39.0625$. Truncates to 39 = Middle byte

Step 4: Adjust the remainder.
EX: $0.0625 \times 256 = 16 = \text{Lowbyte}$

Step 5: Send the command. The specifiers are 0, 39 and 16.

- DECODING DATA BYTES

The desired command is **QUERY POSITION**.

The **QUERY POSITION** command returns two bytes indicating the current wavelength, in the form

<HIBYTE>><MIDBYTE><LOWBYTE>

To be useful to the user, the two bytes must be converted back to a single decimal number. As before, we can do this by either method A or method B, by essentially reversing the above procedures.

For this example, the **QUERY POSITION** command returns the ordered pair (5, 4, 106), HiByte, Lowbyte respectively, as the current wavelength. For this example, the units are in Angstroms.

Method A:

Step 1: Convert each byte to its hex equivalent
HiByte: $05(\text{base } 10) = 5(\text{base } 16)$
Midbyte: $04(\text{base } 10) = 4(\text{base } 16)$
Lowbyte: $106(\text{base } 10) = 6A(\text{base } 16)$

Step 2: Concatenate the 3 bytes to form one hex number
 $05 | 04 | 6A = 05046A(\text{base } 16)$

Step 3: Convert the hex number to a decimal
 $05046A(\text{base } 16) = 328810 = 3288.10 \text{ nm}$.

Method B:

Note: All of the following numbers are in hundredths of nm.

Step 1: Use the formula:
 $\text{Wavelength } (\lambda) = (\text{HiByte} \times 65536) + (\text{Midbyte} \times 256) + \text{Lowbyte}$
 $(5 \times 65536) + (4 \times 256) + 106 = 328810 \text{ hundredths of nm} = 3288.10 \text{ nm}$



8.4 Status Bytes

Whenever the DK240/480 is given a command, it will respond with a status byte that indicates whether the command was accepted. Each bit in the status byte has a meaning, which is given below. When a command is not accepted, some of the bits of the status byte will indicate the reason. In general, if <Status Byte>_D is smaller than 128, then the command was accepted.

- Bit 7: 0 if specifier value acceptable (bit 4 active, bits 5,6 inactive).
1 if specifier value not acceptable (bits 5,6 active, bit 4 inactive).
- Bit 6: 0 if specifier value not equal to present value (bit 5 active)
1 if specifier value equal to present value (bit 5 inactive)
- Bit 5: 0 if the specifier was too small
1 if the specifier was too large
- Bit 4: 0 if scan is negative going (GOTO and SCAN only)
1 if scan is positive going (GOTO and SCAN only)
- Bit 3: 0 not used
- Bit 2: 0 if monochromator is not in CSR mode.
1 if monochromator is currently in CSR mode
- Bit 1: 0 not used
- Bit 0: 1 if motor movement in negative orders (for ZERO operation only)
0 if motor movement in positive order (for ZERO operation only)



8.5 Novram Program

These commands are **Read from Novram** and **Write to Novram**. There are 128 memory locations in the Novram, and their addresses are from 0 to 127. Table on page 40 gives the address and the meaning in the Novram memory.

8.5.1 READ FROM NOVRAM

These commands read a word (0 to 65535) to a Novram address (1 to 64) indicated by address byte.

To DK240/480: <56> D
From DK240/480: <56> D
To DK240/480: <Address Byte>
From DK240/480: <Data High Byte><Data Low Byte>
DK240/480 Action: No immediate action. The word read from the Novram address is (256*<High Byte><Low Byte>)
From DK240/480: <Status Byte>
From DK240/480: <24> D

Data Byte contains a returned value, and *Address Byte* is 0 through 127.

8.5.2 WRITE TO NOVRAM

These commands write a word (0 to 65535) to a Novram address (1 to 64) indicated by address byte.

WARNING !!!
Improper use of this command may corrupt the configuration and calibration information of the monochromator. See 'Restore Disk' supplied to restore values

To DK240/480: <59> D
From DK240/480: <59> D
To DK240/480: <Address Byte>
<Data High Byte><Data Low Byte><Checksum Byte>
DK240/480 Action: No immediate action. Writes a word (2 bytes) to the monochromator's non-volatile memory. *CheckSum Byte = Address Byte + Data High Byte + Data Low Byte*. The addition is operated in one byte method. The Carry bit will truncate if it exists. Therefore, it is always Checksum <=255.
From DK240/480: <Status Byte>
From DK240/480: <24> D



8.6 RS-232 (Serial) Connection Diagram

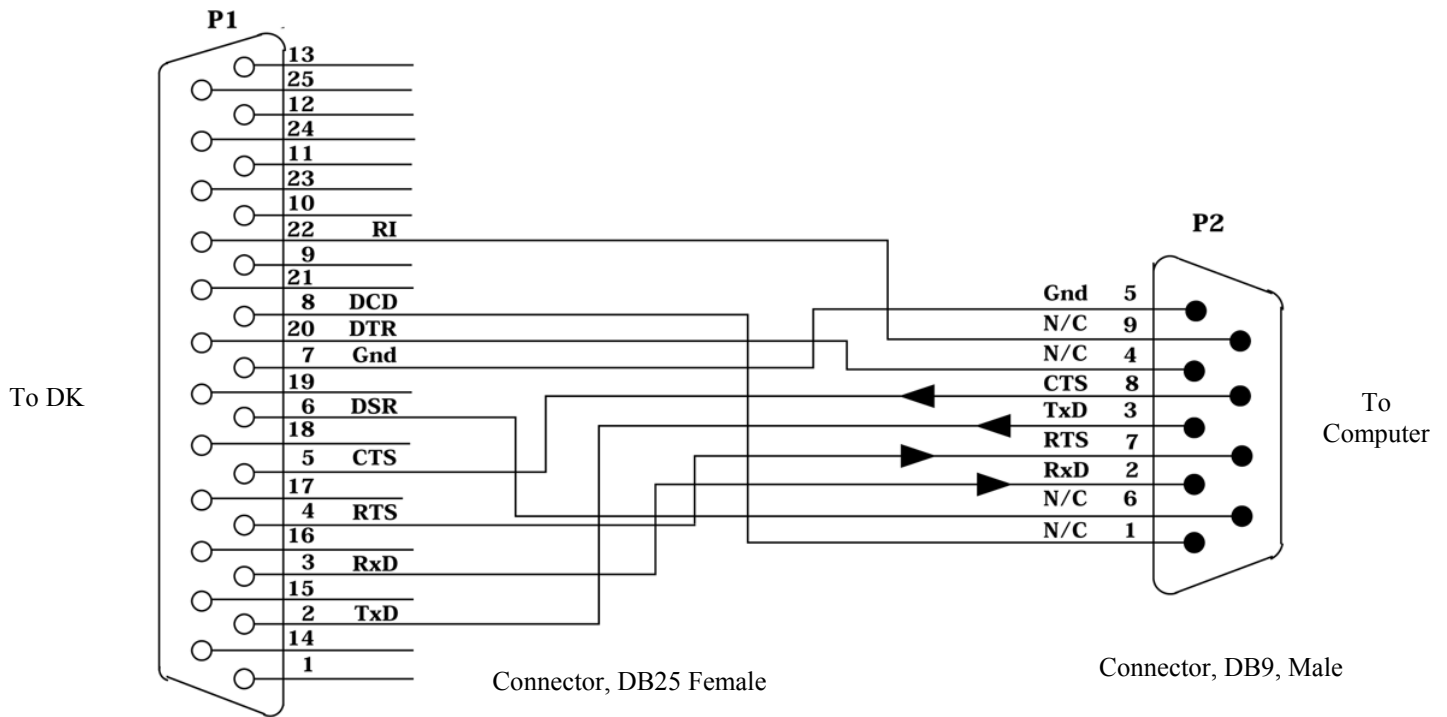

Fig. I-2 DK To PC 25-Pin Serial Port

NOVRAM ADDRESS

Address	The meaning of the content
1	AAAAH if programmed, else random
2	Serial Number
3	Source 1 (not used)
4	Source 2 (not used)
5	Source 3 (not used)
6	Source 4 (not used)
7	High byte: Current source (not used) Low byte: IEEE address
8	Number of motor steps of Slot 1
9	Number of motor steps of Slot 2
10	Number of motor steps of Slot 3
11 / 42	Grating 1 Blaze
12 / 43	Grating 2 Blaze
13 / 44	Grating 3 Blaze
14 / 45	Zero Offset of Machine 1, Grating 1
15 / 46	Zero Offset of Machine 1, Grating 2
16 / 47	Zero Offset of Machine 1, Grating 3
17 / 48	Zero Offset of Machine 2, Grating 1
18 / 49	Zero Offset of Machine 2, Grating 2
19 / 50	Zero Offset of Machine 2, Grating 3
20 / 51	Grating 1 Calibration, High byte
21 / 52	Grating 1 Calibration, Low byte
22 / 53	Grating 2 Calibration, High byte
23 / 54	Grating 2 Calibration, Low byte
24 / 55	Grating 3 Calibration, High byte
25 / 56	Grating 3 Calibration, Low byte
26 / 57	Entrance Slit Offset
27 / 58	Exit Slit Offset
28 / 59	Middle Slit Offset, for DK242 only
29 / 60	High byte: # of gratings Low byte: Bit 0 – 0 = Full step, 1 = Micro step (1) Bit 1 – 0 = 1 machine, 1 = 2 machine (2) Bit 2 – 0 = no OMA, 1 = OMA (4) Bit 3 – 0 = no CSR, 1 = CSR (8) Bit 4 – 0 = no GPIB, 1 = BPIB (16) Bit 5 – 0 = Unilateral, 1 = Bilateral (32)
30 / 61	Model Number
31 / 62	Grating 1 groove/mm
32 / 63	Grating 2 groove/mm
33 / 64	Grating 3 groove/mm
34	Machine 2 Slot 1
35	Machine 2 Slot 2
36	Machine 2 Slot 3
37	Hi byte not used Low byte subtractive
38	Reserved
39	Reserved
40	Reserved
41	Reserved



8.7 GPIB(IEEE-488) Interface Option

The IEEE-488 Bus(General Purpose Interface Bus) provides an electrical and mechanical system for interconnecting electronic measurement devices. With the GPIB Interface Option installed, the monochromator can be controlled by any GPIB controller. All GPIB commands are echoed back to the controller. The echoed commands have an apostrophe (') appended at the beginning and end of the echo word.

Setting the Digikröm GPIB address.

The GPIB address of the monochromator can be set to any address between 1 and 31. To set or reset the GPIB address, press the "OPTIONS" key, while the READY screen is displayed on the Digikröm Control Module. The control module will display the following:

```
OPTIONS: 1 =  
CALIBRATE
```

Press the "2" key to display the REMOTE screen. The display will then show the following:

```
1 = REMOTE MODE  
2=SET GPIB ADDRESS
```

Press the "2" key again to set or view the GPIB address. The display will show:

```
GPIB ADDRESS = x  
ENTER 1 - 31
```

X is the current GPIB address. Input the desired GPIB address, between 1 and 31, and press the enter key. To exit without changing the GPIB address, press the back arrow key, ←, or the "ENTER" key if no address has been input.

Press any key, except RESET, to return the monochromator to manual control operation.

Timeouts: After initializing the GPIB interface card, set the timeout to longer than 180 seconds. If only one grating is installed in the monochromator the timeout can be set to 90 seconds or longer. The longer timeout allows the monochromator to perform a Grating select routine before a timeout error can occur.

For more information on sending and receiving GPIB commands, see GPIB demonstration program provided with your monochromator.

GPIB status bytes are returned in ASCII form as defined below. The status bytes are enclosed in the back and forward arrow keys (<>) and separated by commas .eg. <OK,SC+,CSR>.

<OK>	-	Command executed and specifier value acceptable
<SV>	-	Specifier value sent is the same as the current value
<SV0>	-	Specifier value is too small
<SV1>	-	Specifier value is too big
<SV2>	-	Invalid CSR bandwidth value sent
<SC+>	-	Positive going SCAN or GOTO(towards longer wavelengths)
<SC->	-	Negative going SCAN or GOTO(towards shorter wavelengths)
<CSR>	-	Monochromator is currently in the CSR mode



GPIB Commands/Query

Specifier value definition

'GOTO XXXXXXXX'	XXXXXXX = wavelength unit, enter as tenths of angstroms
'SCAN XXXXXXXX'	
'GCAL XXXXXXXX'	
'SSPEED yyyy'	yyyy = scan speed in nm/min
'S1CAL ZZZZ'	ZZZZ = slit width in microns
'S2CAL ZZZZ'	
'SLTADJ ZZZZ'	
'S1ADJ ZZZZ'	
'S2ADJ ZZZZ'	
'CSR xxxx'	xxxx = Bandpass value (chart on page 37)
'MANUAL s'	s = step direction, 7 = positive, 1 = negative
'GRTSEL n'	n = Grating number 1, 2 or 3
'ZERO g'	g = machine number 1 or 2
'CLEAR'	
'TEST'	
'WAVE?'	
'SLIT?'	
'*IDN?'	
'ECHO'	

Except for the *IDN? command, all commands operate as defined in Command Summary, page 10. When the *IDN? query is sent, the monochromator will return the firmware identifier string:

<**SP** INSTRUMENTS, DIGIKROM YYYY,XXXXX>

YYY is the model number of the monochromator, 240/242/480, XXXXX is the five digit serial number of the monochromator

After sending the Echo byte of the TEST command, the monochromator will output the TEST status byte.

The monochromator will perform a reset operation after any of the following commands are sent:

*GRTSEL, *GCAL, *S1CAL, *S2CAL, TEST, CLEAR or RESET



Spectral Products

2659-A Pan American Frwy., NE Albuquerque, NM 87107 Tel (505) 343-9700 Fax (505) 343-9705
www.spectralproducts.com

9. Hand Held Control Module Operation

The DK2401 Handheld Controller sends command instructions to the DK240/480.



9.1 Operation

The DK2401 receives power from the monochromator. Connect the controller RS232 cable to the RS232 connector at one end of the DK240/480. Apply power to the monochromator. Press the ON/OFF button of the DK2401 to turn it on. The controller display will read

**Spectral, LLC.
Digikröm, DK-Series**

Once the DK240/480 finishes initialization routines, the controller display will read

Gr/mm: 01200	Grtg: 1/3
SS:0100nm/m	SN:54321
eSW:0050 μ	xSW:0050 μ
READY...	$\lambda = 0100.00\text{nm}$

- *Gr/mm : 01200* - denotes 1200 grating groove per millimeter.
- *Grtg : 1/3* - denotes current grating is 1 of 3 total gratings.
- *SS : 0100 nm/m* - denotes the current scan speed 100 nanometers per minutes.
- *SN : 54321* - denotes the monochromator serial number.
- *eSW : 0050 u* - denotes the entrance slit width, 50 microns.
- *xSW : 0050 u* – denotes the exit slit width, 50 microns.



Spectral Products

2659-A Pan American Frwy., NE Albuquerque, NM 87107 Tel (505) 343-9700 Fax (505) 343-9705
www.spectralproducts.com

- *READY*: - denotes the monochromator is ready to accept commands.
- $\lambda = 0100.00 \text{ nm}$ - denotes the current wavelength at 100 nm.

The keyboard consists of 23 keys, 13 control keys, and 10 number keys, including a decimal point. The numeric keys are used to enter parameter values in response to prompts from the LCD display. The LCD display will prompt the user to enter a value. The user responds by pressing the appropriate numerical keys, and the decimal point key for wavelength operations, correcting erroneous entries with the backspace key. Once the displayed value is correct, the user then presses the ENTER key, and the entry is accepted by the controller. Please note that the numerical entries must agree with the units indicated by the LCD prompts.

The command keys are used to initiate (or halt) the many functions of the Digikröm 240/480. The keyboard layout is shown above. Described below are the various command key functions of the Digikröm monochromator.

- **MANUAL/.** This command allows the user to change the rotation of the grating by one motor step. It also allows the user to set a new zero position for either λ equal to zero or a nonzero value.

The **MANUAL/.** key shifts control of the grating table back and forth between manual and automatic. When the user shifts from AUTO to **MANUAL** mode by pressing the **MANUAL/.** key, the display responds as the image below.

MANUAL:		CNCL=quit
1: Stp--	2:Slw--	3:Run--
7: Stp+	8:Slw+	9:Run+
CURRENT		$\lambda = 0100.00 \text{ nm}$

In **MANUAL** mode, the wavelength of the monochromator is controlled by pressing selected keys on the numerical pad. The numbers on the bottom row 7, 8, and 9, control the scan speed in the increasing wavelength direction, and the numbers on the top row 1, 2, and 3, control the decreasing wavelength scan speed. The numbers on the middle row have no effect on the scan. The 7 or 1 number key in each row produces a single step each time it is pressed. The 8 or 2 number key in each row produces a continuous scan at one half the scan speed, as long as the key is pressed. The 9 or 3 number key in each row will scan at the speed shown in the display.

The user can return control to the AUTO mode by pressing the **MANUAL/.** key again or pressing **CANCEL** key.

All other keys, with the exception of the 1, 2, 3, 7, 8, 9, **CANCEL** and **MANUAL/.** keys, will have no effect on the status of the DK240/480. If the user attempts to use inactive keys while in the **MANUAL** mode, a high pitched inactive key tone will result.

Note: All of the following commands must be executed from the AUTO mode.



- **GOTO** The user can change the λ wavelength by entering a value for a new wavelength and then pressing enter. This command changes the grating angle, which in turn changes the wavelength at the exit slit.

Use the **GOTO** command to instruct the DK240/480 to find a discrete wavelength. The values of wavelength are grating dependent. Once the key is pressed, the display reads:

ENTER: goto	CNCL=quit
CURRENT	$\lambda = 0100.00$ nm
GOTO	$\lambda = \text{xxxx.xx}$ nm

ENTER. During this part of the operation, the display reads:

ENTER: goto	CNCL=quit
CURRENT	$\lambda = 0100.00$ nm
RUNNING.....	

Once the DK240/480 finds the specified wavelength, the **GOTO** operation stops and the **READY** screen appears.

- **SCAN** The user can scan the intensity of light leaving the exit slit over a wavelength range defined as $\lambda_1.\lambda_2$.

The user can scan different ranges of wavelength by entering the values of λ_1 and λ_2 with this command, then pressing enter.

The **SCAN** key allows the user to scan between a start and an end position specified by the user. The **START** position(λ_1) may be greater or smaller than the **END** position(λ_2). Valid values of position are grating dependent. The scanning speed for the **SCAN** command is a constant and is determined by the user. Once the **SCAN** key is pressed, the display reads:

ENTER: scan	CNCL=quit
CURRENT	$\lambda = 0100.00$ nm
ENTER	$\lambda_1 = \text{xxxx.xx}$ nm

Type the starting wavelength and press **ENTER.** The display will then read:

ENTER: scan	CNCL=quit
CURRENT	$\lambda = 0100.00$ nm
ENTER	$\lambda_2 = \text{yyyy.yy}$ nm



Type the ending wavelength and press **ENTER**. The display will then read:

SCAN:	CNCL=quit
# of Repetitions :	
Enter Numbers :	rrr

Type a number from 1 to 999. Press Enter. If no number is typed and you press Enter, scan will start and complete one repetition. If you enter a number, the display will then read:

SCAN:	CNCL=quit
# of Repetitions :	rrr
Secs to Pause :	ppp

Type a number from 1 to 999. Press Enter. If no number is typed and you press Enter, the scan will start, completing one repetition. If you enter a number, the display will then read:

SCAN:	CNCL=quit
λ' = xxxx.xx -	λ'' = yyyy.yy
Rep. : rrr	Sec. : ppp
Scanning.....	Secs to Pause : ppp

After the number is entered, the scan will begin. When the scan is complete, the **READY** screen will be displayed.



- **SCAN SPEED** This command selects the speed at which the DK240/480 will scan the intensity of light at the exit slit for a given wavelength range. The user should refer to Appendix B, for a list of scan speeds that are appropriate for various gratings.

The **SCAN SPEED** key allows the user to control the rate at which the wavelength changes. Values of speed are grating and units dependent and are given in Appendix E. Once the key is pressed, the display reads:

#=next	CNCL=quit
1: Scan Speed	
2: Rd. Novr.	3: Wr. Novr.
Enter Selection : _	

Caution: do not press number 3. This will change factory settings.

Press 1 and display will read

- **SCAN SPEED**

ENTER=new	CNCL=quit
CURRENT SCAN SPEED: xxxx nm/m	
NEW SPEED :	yyyy nm/m

‘xxxx’ is the current scan speed. Enter new scan speed and press Enter. The display will return to Scan Speed screen. Press Cancel, the Ready screen will be displayed, and the new speed will be displayed within the screen (SS).

- **Rd Novr. (Read Novram)**

READ NOVR.	CNCL=quit
Address [1-64] :	xx
Novram Value :	yyyy
Address + Enter :	zz

Enter the new ‘zz’ address and press Enter. The ‘xx’ will be replaced by ‘zz’, and the controller will query the Novram Value and will display the value in ‘yyyy’ location. User can increase the xx address by pressing Options key or decrease the xx address by pressing Scan Speed key.



- **Wr. Novr. (Write Novram)**

OPT'N: Addr	CNCL=quit
Address [1-64] :	xx
Value [0-65535] :	yyyy
Value + Enter :	zzzz

Enter the 'zzzz' value and press Enter. The 'yyyy' will be replaced by 'zzzz', and the controller will send a command to write the 'yyyy' value to the 'xx' Novram address. User can increase the 'xx' address by pressing OPTIONS key or decrease the 'xx' address by pressing SCAN SPEED key.

- **SLIT ADJ** This command allows the user to change slit widths.

This **SLIT ADJ** allows the user to adjust the entrance and exits slits to desired widths. The power up default slit width is 50 microns. This width may be changed to any value between 10 and 3000 microns in the **SLIT ADJ** routine. After the **SLIT ADJ** is pressed, the display will read:

ENTER: new	CNCL=quit
0: All	1: Ent. 2: Exit
	4: Reset 5: Cal.
Enter Selection :	_

DK242 only

ENTER: new	CNCL=quit
0: All	1: Ent. 2: Exit
3: Mid.	4: Reset 5: Cal.
Enter Selection :	_

If '0' is pressed, the screen will display the box that allows a user to enter a new width for all slits. If '1' is pressed, a user can enter a new width for entrance slit. And, the same way for number '2' that is used for exit slit. Pressing **CANCEL** will cancel any **SLIT ADJ** routine and return to the **READY** screen.



If '4' is pressed, the Reset Slit screen will be shown. Then, a user can select '0' for all, '1' for entrance slit, and '2' for exit slit.

If '5' is pressed, the Slit Calibration screen will be shown. A user can calibrate the entrance or exit slit.

***CAUTION:** Use of the slit calibration will erase factory settings.*

- **SLIT ADJ**

ENTER: new	CNCL=quit
CURRENT WIDTH:	0050 μ
ALL SLITS	
NEW WIDTH? :	xxxx μ m

ENTER: new	CNCL=quit
CURRENT WIDTH:	0050 μ
Entrance SLIT	
NEW WIDTH? :	xxxx μ m

ENTER: new	CNCL=quit
CURRENT WIDTH:	0050 μ
Exit SLIT	
NEW WIDTH? :	xxxx μ m

- **SLIT RESET**

ENTER: reset	CNCL=quit
0: All	1: Ent. 2: Exit
NEW WIDTH? :	xxxx μ m

ENTER: reset	CNCL=quit
0: All	1: Ent. 2: Exit
Running.....	

If '0' is pressed, all slits will be reset. '1' is for Entrance slit, and '2' is for Exit slit.



- **SLIT CALIBRATION**

This command will allow a user to calibrate entrance and exit slits.

```
ENTER: new          CNCL=quit
  SLITS  CALIBRATION
1: Entrance          2: Exit
Enter Selection :
```

```
ENTER: new          CNCL=quit
----SLITS  CALIBRATION----
  Current  Width  :    0050 μ
  Desired  Width  :    xxxx μ  _
```

CAUTION: Use of this command will erase factory settings.



- **QUERY** This key contains three different functions: Test, Slot Width, and GPIB address.

1: Test	CNCL=quit
2: Slot Width	3: GPIB
Enter Selection : _	

- **Test** Initiates an internal diagnostic routine and resets the monochromator. Similar to RESET.

1: Test	CNCL=quit
2: Slot Width	3: GPIB
DK is OK	
Enter Selection : _	

If '1' is pressed, the below images is shown on LCD. After the test, the LCD will display either "DK is OK" or "DK is Not OK".

- **Slot Width** Displays the current slot width of the grating turret table.

1: Test	CNCL=quit
2: Slot Width	3: GPIB
Slot Width is :	xxxxx
Enter Selection : _	

After the '2' is pressed, the xxxxx will shown on LCD. The xxxxx is the current slot width of the turret table.

- **GPIB** Sets the monochromator GPIB address if available.

ENTER: set	CNCL=quit
OPT'N : up	SCNSPEED:dn
GPIB Address :	09
New Addr. (1-31) :	xx

If **ENTER** is pressed, 'xx' is the new address that will replace '09'. 'xx' can be increased by pressing **OPTIONS** or be decreased if **SCAN SPEED** pressed.

- **OPTIONS** This command offers 3 menu commands to change all calibrations, grating selection, and constant spectral resolution (CSR) function.

In the event that you feel the instrument needs recalibration, this can be initiated from the control module or external computer via the RS-232 cable. At this point, the monochromator must be set to a known wavelength that you have determined by means external to the DK240/480 (laser, atomic line, etc).

NOTE: *Grating calibration should only be performed after grating zero is checked, and if necessary, re-zeroed using the **OPTIONS** command.*

OPTIONS:	CNCL=quit
1: Calibration	
2: Grating	3: CSR
Enter Selection :	_

- **Calibration**

The **Calibration** command offers four functions: Calibrate Grating, Zero, Calibrate Slits, or Clear. Once selected, each option has submenus that will prompt the user for information. Pressing the ‘**Cancel**’ will exit the **OPTIONS** mode and return to the **READY** screen.

CALIBRATE:	CNCL=quit
1: Cal. Grating	2. Zero
3: Cal. Slits	4: Clear
Enter Selection :	_

- **Cal. Grating**

This command allows recalibration of the monochromator positioning scale factor and should ALWAYS be used immediately after the ZERO command. The monochromator should be set to the peak of a known spectral line, then the position of that is input using the CALIBRATE command.

CAUTION: *Use of this command will erase factory settings.*

GRATING CALIBRATION	
	CNCL=quit
Current λ :	xxxx.xx nm
Desired λ :	yyyy.yy nm



You then enter the externally established wavelength and the DK240/480 adjusts its calibration point then performs a hardware reset. At the end of the reset cycle the new calibration will be in effect. If problems are encountered during this procedure, consult **SP** for assistance.

Limits have been set on the extent to which you can alter the factory calibration of the DK240/480. If the display indicates the desired calibration parameter is too large or too small then the method for determining the calibration point should be reviewed. Grating wavelength limits are shown below.

Groove/mm	Limit (nm)	Groove/mm	Limit (nm)	Groove/mm	Limit (nm)
3600	500	600	3000	75	24000
2400	750	300	6000	50	36000
1200	1500	150	12000	20	80000



- Zero** The **Zero** command will make the current grating position 0.00nm. User can use 1, 2, 3, 7, 8, 9 keys to set to the peak of the zero order transmission for each grating. If the peak is on the negative side of zero order, a user must use '1' to step down. If the peak is found, **ENTER** key will be pressed to set the current grating to 0.00nm. 'xxxxx' is the previous zero offset value, and 'yyyyy' is the new zero offset value after **ENTER** had been entered.

CAUTION: Use of this command will erase factory settings.

ZERO:	CNCL=quit
Zero Offset 1 :	xxxxx
DK is moving to 0 nm	

ENTER: Zero	CNCL=quit
1: Stp--	2:Slw-- 3:Run--
7: Stp+	8:Slw+ 9:Run+
CURRENT	$\lambda = 0000.00 \text{ nm}$

ENTER: Zero	CNCL=quit
1: Stp--	2:Slw-- 3:Run--
7: Stp+	8:Slw+ 9:Run+
Is below	0.00 nm

ENTER:	CNCL=quit
Zero Offset 1 :	xxxxx
Zero Offset 1 :	yyyyy



- **Cal. Slits**

This command allows a user to calibrate entrance and exit slits.

CAUTION: Use of this command will erase factory settings.

```

ENTER: new          CNCL=quit
      SLITS  CALIBRATION
1: Entrance          2: Exit
Enter Selection :  _
  
```

```

ENTER: new          CNCL=quit
----SLITS  CALIBRATION----
  Current  Width  :    0050 μ
  Desired  Width  :    xxxx μ
  
```

- **Clear**

This command restores factory calibration values for the grating and slits. It also executes a reset, which returns the grating to home position.

```

CALIBRATE:          CNCL=quit
1: Cal. Grating     2: Zero
3: Cal. Slits       4: Clear
RUNNING .....
  
```

- **Grating**

When the ‘Grating’ is selected, the LCD shows the current grating groove per millimeter, the current grating number per total gratings, the current grating blaze in nanometers, and the selection for the grating if the total grating is more than 1. If the new grating is selected, it takes more than two minutes to change to a new grating.

```

GRATING:           CNCL=quit
Gr/mm : ggggg      Grtg : 1/3
Blaze (nm) : bbbb
Enter New Grating : x
  
```



GRATING:	CNCL=quit
Gr/mm : 00600	Grtg : 1/3
Blaze (nm) : 1000	
RUNNING	

- **CSR**

This command sets the monochromator to Constant Spectral Resolution (CSR) mode. The slit width will vary throughout a scan.

- *xx.xx nm* - is the maximum allowed for current grating.
- *yy.yy nm* - is the current bandwidth.
- *zz.zz nm* - is the new width that will be set.
-

User can use **OPTIONS** or **SCAN SPEED** key to adjust the new width.

OPT'N: next	CNCL=quit
Maximum BW :	xx.xx nm
Bandwidth :	yy.yy nm
New Width :	zz.zz nm

The CSR function is described in further detail below.

- **ENTER/ STOP**

Press the **ENTER/STOP** key after every command to carry out that action.

- **RESET**

This command resets the grating turret to the home position. The READY screen will be displayed after the reset has been completed.

<p>SPECTRAL PRODUCTS Monochromator Is Resetting Waiting</p>



- **FILTER**(Optional)

This option is enabled when an AB300-T filter wheel is attached. The Filter option is described in detail in the Filter operations chapter. The Filter option allows you to rotate the 6 position filter wheel assembly so that the selected filter will be placed in the monochromator beam path. You may select any one of up to six filter positions.

```

FILTER:                                CNCL=quit
Current Filter :  x
*****
New Filter ? [ 1 - 6 ] : y
-----
  
```

```

FILTER:                                CNCL=quit
Current Filter :  x
*****
Running .....
-----
  
```

- **INVALID VALUE ENTRY**

Whenever a value is entered that is out of the grating range, the following screen appears

```

                VALUE INVALID
                HIT ANY KEY TO CONT.
-----
  
```

When an invalid value is entered for grating SCAN SPEED, the following screen appears

```

Invalid key .....
HIT ANY KEY TO CONT.
-----
  
```



- Constant Spectral Resolution (CSR)

Theory

The CSR mode allows the DK240/480 to vary the slit widths throughout a scan. This is useful, for example, where measurement of a constant interval of frequency is desired (spectral power distribution measurements). With the exception of slit setting, operation in the CSR mode leaves the other functions unchanged. When the monochromator is positioned using GOTO, or scanned using SCAN, the slit widths will be continuously and automatically adjusted to provide constant bandwidth.

The spectral dispersion of a monochromator is frequently quoted in units of nanometers per millimeter of exit width. However, the spectral dispersion is a function of wavelength. The spectral dispersion will change by about a factor of two as a single grating is scanned over its full range. When a monochromator with fixed slits is scanned over a wide wavelength range, the change in spectral dispersion will change the bandwidth of light that is passed by the fixed slits.

In the Constant Spectral Resolution mode (CSR), a changing slit width compensates for the changing dispersion to maintain fixed spectral resolution. Instead of selecting fixed slit widths, the user selects a fixed band pass. At each wavelength, the Digikröm then sets the slit width to allow the pre-selected bandwidth to be maintained.

Some important limitations apply to this method:

- The effective entrance and exit slit widths may be limited by the source and detector. If the source is imaged on the entrance slit, and if that image width is less than the slit width, then change of the physical slit width will have no effect. Similarly, if the exit slit is imaged on a detector, and if that detector is smaller than the slit image, changing the physical slit width will again have no effect.
- The resolution of a monochromator depends in part on uniform illumination of the grating. If uniform illumination is not maintained as the slits are widened, then constant spectral resolution may not be obtained.
- The slit settings are not continuously variable; the changes in the slit widths that are used to maintain constant spectral resolution may result in observable steps in the output intensity. To restrict this effect, the smallest slit width that is used in the CSR mode is 106 microns or 1% of the slit width increment.



The CSR mode is selected by pressing the **SLIT ADJ** key four times. The display will respond as shown below.

BANDWIDTH = xx.xxnm

If the monochromator is currently in the CSR mode, then XX.XX will be the current bandwidth. If the monochromator is not in the CSR mode then XX.XX will be the maximum allowed bandwidth for the current grating. The CSR bandwidth is entered at the prompt, using the numeric keys, then pressing the ENTER/STOP key. The bandwidth should be selected from the allowed band pass values listed below.

If an invalid bandwidth has been entered, a beep will sound and the display will not change. If a valid bandwidth has been selected, the slit widths will be automatically adjusted and the display will return to the READY screen. When the CSR mode has been selected, the character for current grating number, at the top right corner of the READY screen, will be displayed in reverse video (white on black). To escape from the CSR display without entering a value, press the cancel key.

- **Specifications**

The allowed band pass (resolution) values in the CSR mode are given below. With uniform grating illumination and effective slit widths determined only by the physical slits, the actual band pass values will be within $\pm 9\%$ of the nominal value.

Grating (lines/mm)	Allowed Band pass Values (nanometers)			
2400	1.50	0.75	0.37	0.18
1200	3.00	1.50	0.75	0.37
600	6.00	3.00	1.50	0.75
300	12.0	6.00	3.00	1.50
150	24.0	12.0	6.00	3.00
75	48.0	24.0	12.0	6.00

The instrument can be removed from the CSR mode in the following five ways:

- By selecting a specific slit setting
- By selecting a new grating
- By resetting, recalibrating, or clearing the instrument
- By selecting the TEST function
- By removing power from the instrument



10. Reference Drawings

10.1 Optical Diagram of DK240/480

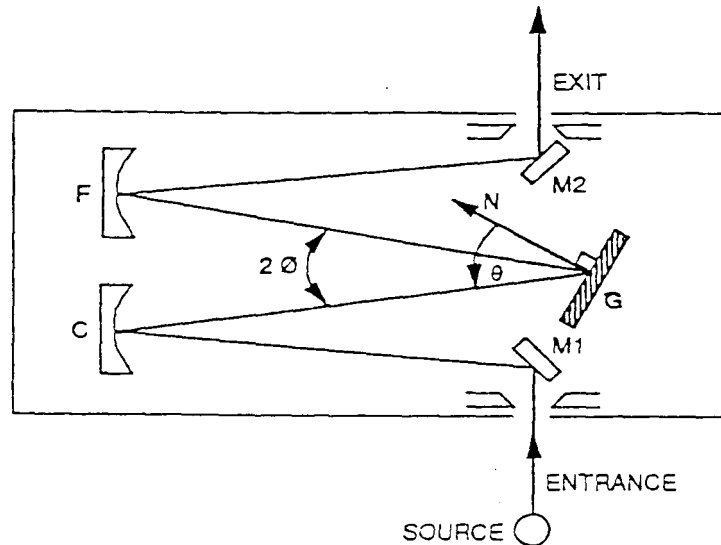

As indicated above, light from a source is focused on the entrance slit and directed by the turning mirror, **M1**, to the collimating mirror, **C**. The focused beam is collimated and directed to the grating, **G**, which diffracts and reflects the radiation. A particular wavelength of the light, determined by rotation of the grating, is directed to the focusing mirror, **F**, which focuses it onto the exit slit via the second turning mirror, **M2**.

10.2 Optical Diagram of DK242

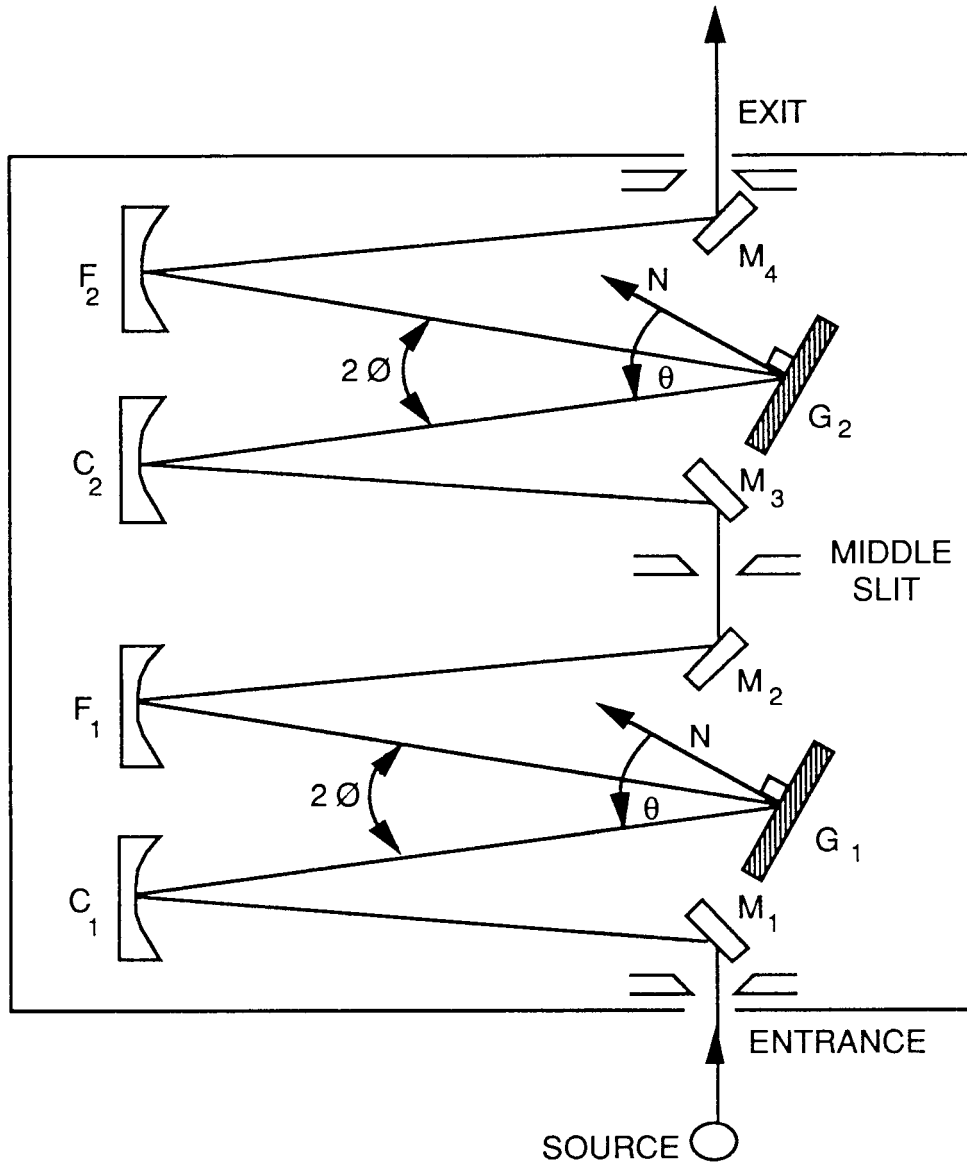

As indicated above, light from a source is focused on the entrance slit and directed by the turning mirror, **M1**, to the collimating mirror, **C**. The focused beam is collimated and directed to the grating, **G**, which diffracts and reflects the radiation. A particular wavelength of the light, determined by rotation of the grating, is directed to the focusing mirror, **F**, which focuses it onto the exit slit via the second turning mirror, **M2**.

Optical baffles are utilized to minimize stray light due to scattering from slit edges and dust or aberrations in the optical elements.

11. Calibration

11.1 Calibrating Zero with DK2401

Recalibration will erase the values previously programmed in your NOVRAM's memory.

- Using a discrete light source, such as a HeNe laser, illuminate the entrance slit. Make sure the light source is aligned perpendicular to the entrance slit.
- Using **SLIT ADJ**, set both slits to 50 μ
- Press **GOTO** and set $\lambda = 0$ nm
- Using a white card, look for the laser beam exiting the monochromator.
- Pressing 1 will single step the grating below zero. Pressing 7 will single step grating above zero. Step up and down until the brightest light is seen at the exit slit.
- Press **OPTIONS**, then 1 (calibration), then 2 (zero).
- Then, press **ENTER** to re-zero the monochromator.

11.2 Calibrating a Wavelength with DK2401

Recalibration will erase the values previously programmed in your NOVRAM's memory.

- Zero **MUST** be set before wavelength calibration,
- Using a discrete light source, such as a HeNe laser, illuminate the entrance slit. Make sure the light source is aligned perpendicular to the entrance slit.
- Press **GOTO** and set $\lambda = 0$ nm. Press Enter.
- Using a white card, look for the laser beam exiting the monochromator. If beam is not seen, see above section.
- Press **GOTO** and set $\lambda =$ (laser wavelength, i.e. 632.8nm).
- Using a white card, look for the laser beam exiting the monochromator.
- If the new wavelength is not correct, enter into **MANUAL** mode
- In **MANUAL** mode:
 - 1 – single step below current λ
 - 2 – scan below current λ
 - 3 – slew below current λ
 - 7 – single step above current λ
 - 8 - scan step above current λ
 - 9 - slew step above current λ
- It is best to single step, while observing detector for maximum peak intensity. Press **MANUAL** again to get back to the Ready screen.
- To calibrate this new wavelength, Press **OPTIONS**.
- Press 1, Calibration
- Press 1, Cal Grating
- Type new wavelength
- 1. Press Enter.

Note: The CANCEL key will allow you to exit this procedure at any time.



11.3 Slit Calibration

Recalibration will erase the values previously programmed in your NOVRAM's memory.

Pressing the keys "OPTIONS" then "1" then "3" will initiate slit calibration and will produce similar displays and invoke the slit calibration routines. Please consult **SP** before proceeding. As with the grating calibration, the slits must be set to a known width by a method external to the monochromator before recalibration. The most practical method is diffraction pattern measurement, whereby laser light is passed through relatively narrow slits and the main beam of the diffraction pattern is measured.

Place a white card in front of the spherical mirror nearest the slit being calibrated and observe the laser diffraction. Properly calibrated slits will have a main diffracted beam of 12.7mm for a DK240 or DK242, and 25.4mm for a DK480 when the slits are set to 25 microns.

11.4 Calibrating Zero with DKDemo VB Software

Recalibration will erase the values previously programmed in your NOVRAM's memory.

- Using a discrete light source, such as a HeNe laser, illuminate the entrance slit. Make sure the light source is aligned perpendicular to the entrance slit.
- Using the DKDemo-F program, click Commands, Control, Goto drop down tabs and enter 0 for the wavelength, and then press OK.

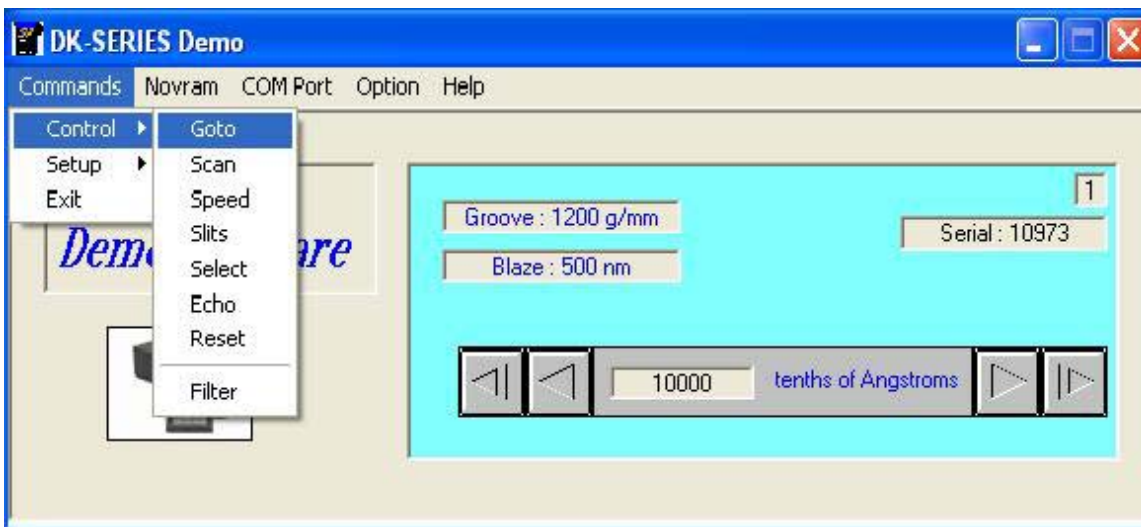

- Click Commands, Control, Slits to set entrance and exit slits to 50 μ .
- If the beam exits the monochromator, no further action is needed.



- If the beam does not exit the monochromator, click Commands, Setup, Zero.

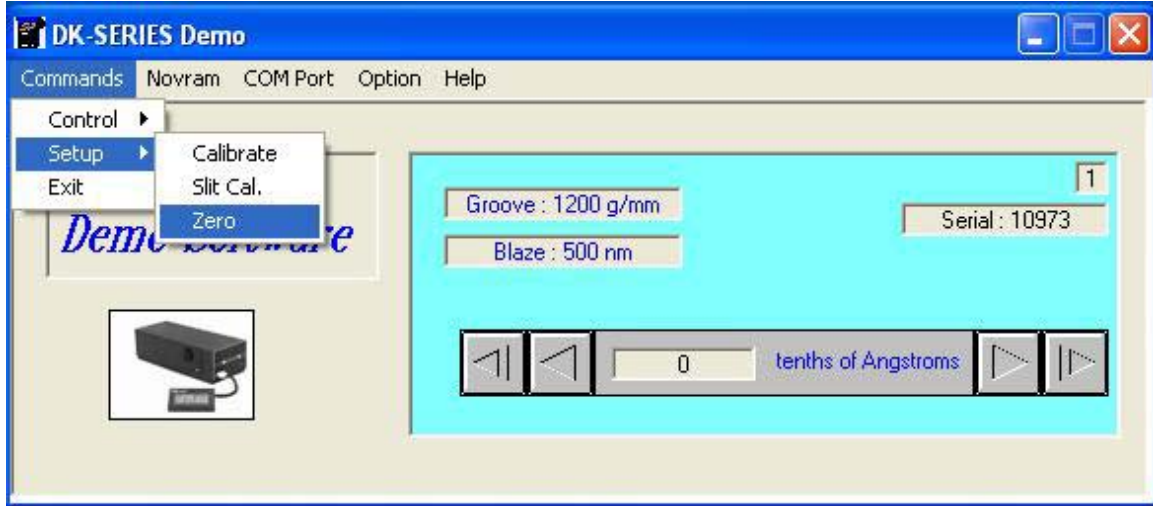

A new window will pop up. Click on the up/down arrow buttons until the beam exits. Press Zero to issue a new zero offset for the grating.



11.5 Calibrating a Wavelength with DKDemo VB software

Recalibration will erase the values previously programmed in your NOVRAM's memory.

- Zero **MUST** be set before wavelength calibration,
- Using a discrete light source, such as a HeNe laser, illuminate the entrance slit. Make sure the light source is aligned perpendicular to the entrance slit.
- Click Commands, Control, Goto drop down tabs and enter 0 for the wavelength. Check to see that the zero offset is correct for the grating in use. If not refer to the zero calibration above.
- Click Commands, Control, Goto drop down tabs and enter the wavelength you wish to calibrate the grating.

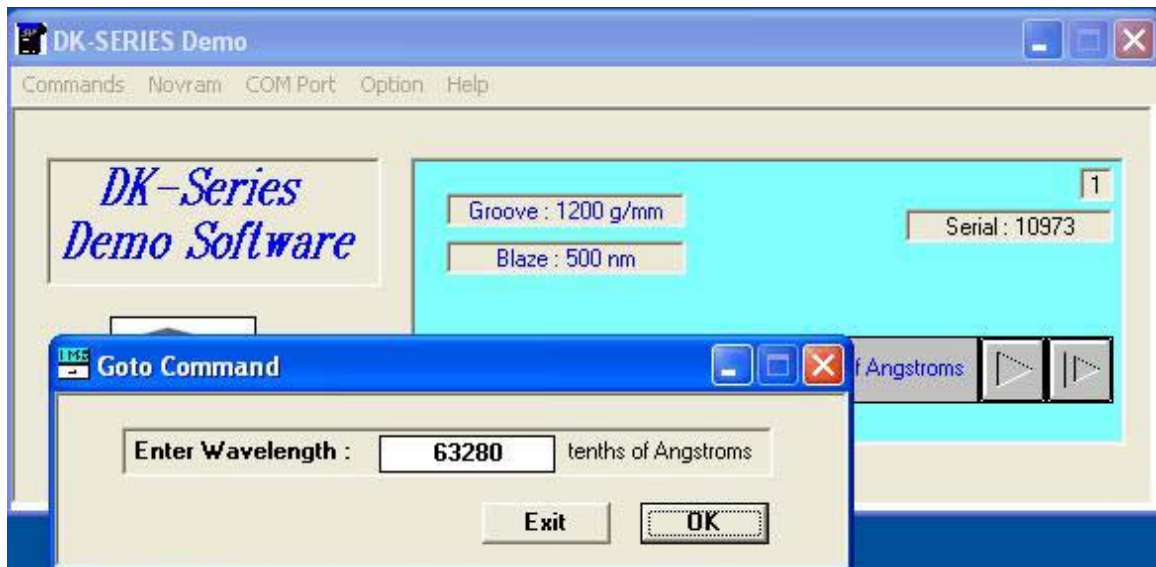

- If the current calibration offset is unsatisfactory, click the step up/step down buttons until the laser line exits.
- Click Commands, Setup, Calibrate. A second box will pop up showing the current wavelength (Goto wavelength). Enter the desired wavelength, i.e. the laser wavelength.

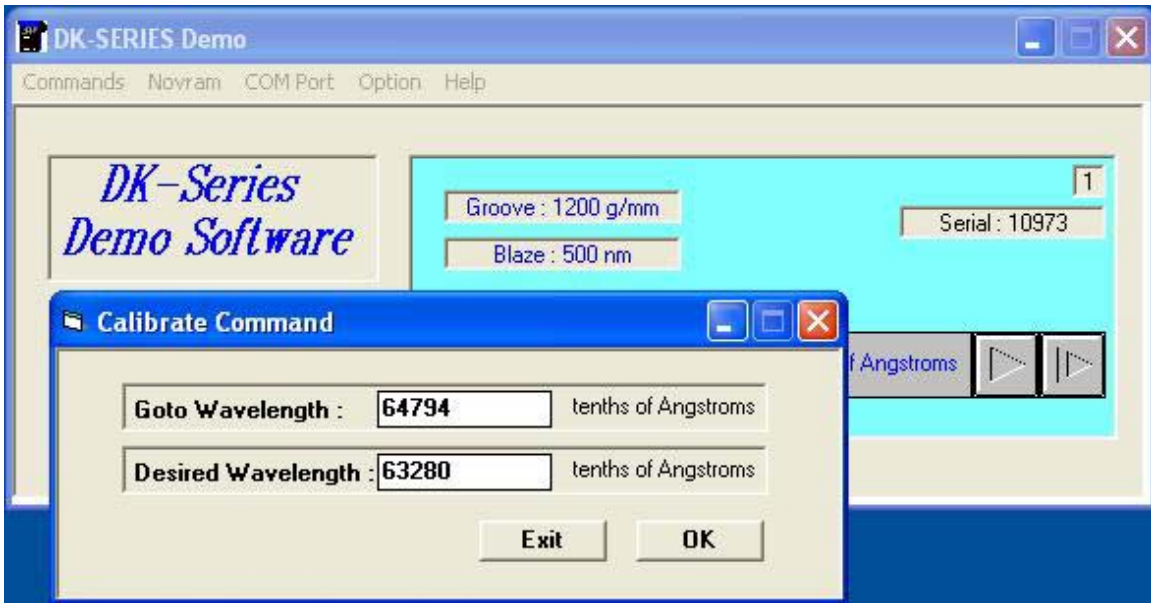

The monochromator will perform a Reset.

11.6 Slit Calibration Using DKDemo VB Software

Recalibration will erase the values previously programmed in your NOVRAM's memory.

As in slit calibration procedures above, slit calibration must be done very carefully. Issuing a wrong number can result in damage to the slit blades.

- Click the Commands, Setup, Slit Cal drop down tabs. A second box will pop up, asking which slit you are calibrating, and what the correct slit width should be.



11.7 DK242 Calibration

The DK242 establishes a zero order offset value for each half of the monochromator. In other words, each grating has its own zero offset. Calibration offset is different in that one value is established for each pair of gratings. It is very important to have the DK242 zeroed properly to receive a satisfactory output from the monochromator.

The DK242 MUST be properly zeroed before it can be calibrated.

Zero and calibration is best performed using the DKDEMO-F software included on the Software Installation Disk received with your monochromator. The following instructions reference the DKDEMO-F software.

You will need two small hex wrenches (1/16" and 3/32") and a visible light source for this procedure. A laser source such as a HeNe works best, but it can be done with a white light or atomic line pen lamp.

- Remove power from the unit. Remove the slit cover plates and remove the cover.
- Apply power and set your light source to the entrance slit. Once the DK242 has finished its reset routine, open the DKDEMO-F software. Click the Commands, Setup, and Zero tabs. A new window will pop up as shown below:

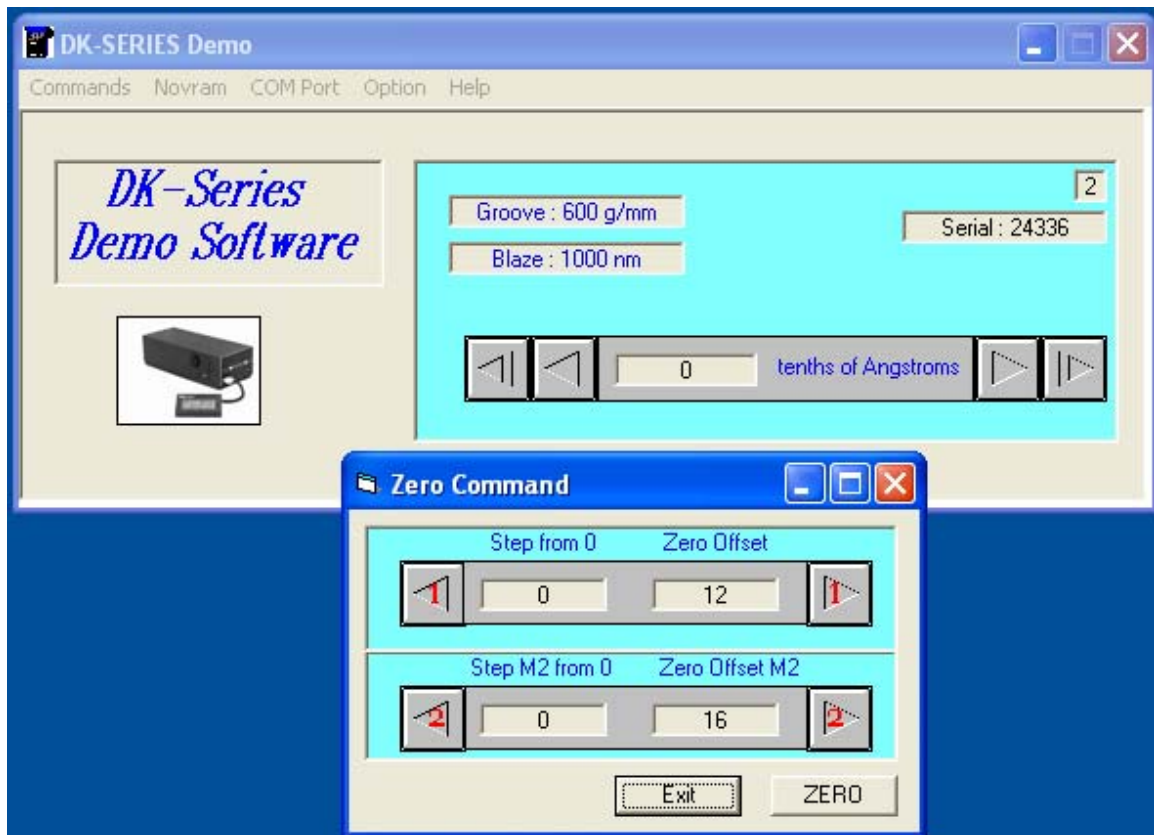

- The grating turrets will rotate to the current Zero order position. While observing the light source through the middle slit, press the radio buttons labeled 1 to optimize the light passing through the slit. The left button steps the turret below the current zero offset, the right button steps the turret upward.
- Once the light sufficiently exits the first half of the monochromator, repeat the above procedure using the radio buttons labeled 2, to get the light to exit the entire monochromator.
- Once the light exits the entire monochromator correctly, click the zero radio button. A warning screen will appear as shown below. Press the Continue button to zero the monochromator turrets. The monochromator will perform a reset.

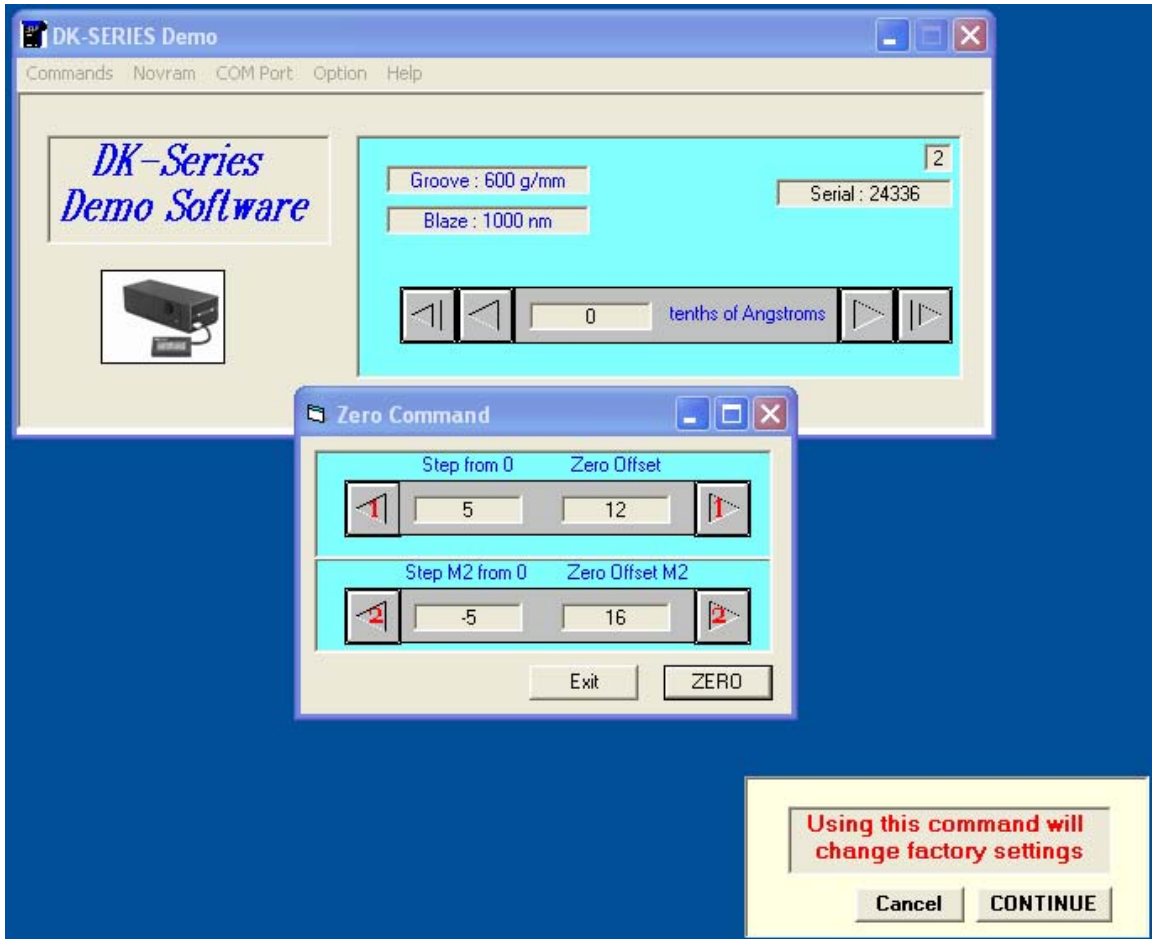

- Press the Exit button to leave the zero routine.



- Again using the DKDEMO-F program, press Commands, Control, GoTo and enter a known spectral line of the source you are using. In this example we have entered 546.07nm.

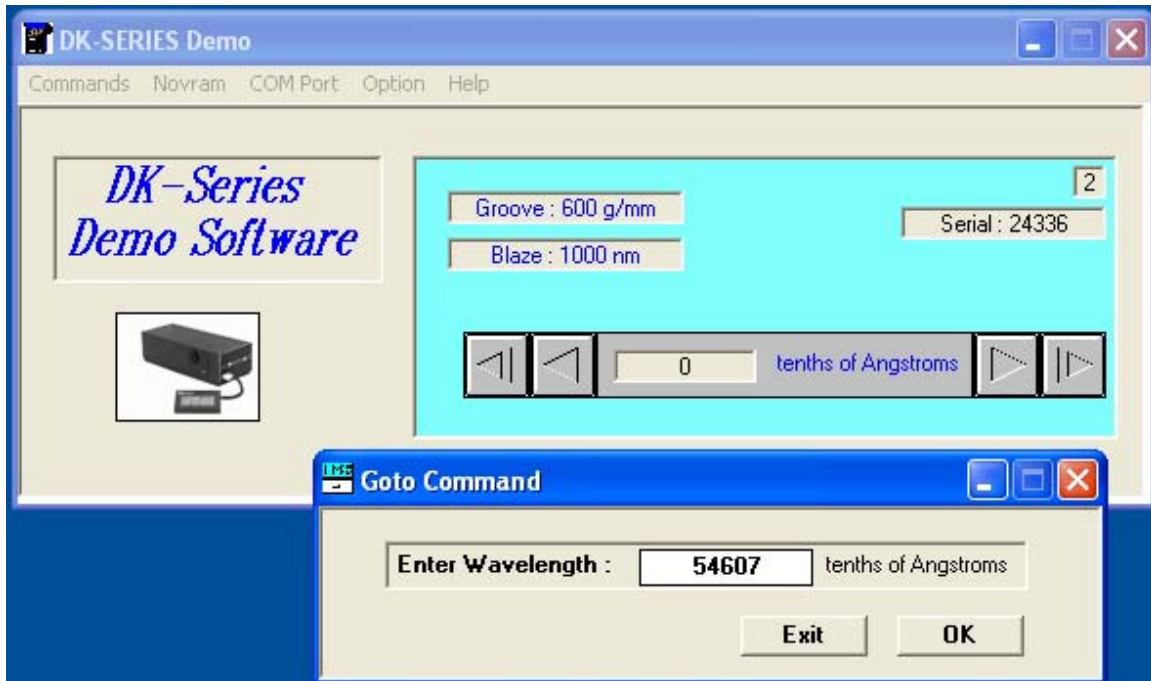

- If the wavelength light exits the monochromator, no further action is required. If the light does not exit, use the radio buttons on the main view to step the turrets until the light exits properly.
- Click the Commands, Setup, and Calibrate tabs to calibrate the monochromator. In the example below, we stepped the monochromator to 546.52nm to get the 546.07nm line to exit. Ensure that the Desired Wavelength matches the known wavelength you have chosen to calibrate the instrument.
- Press the OK button to calibrate the DK242. Again a warning window will appear.



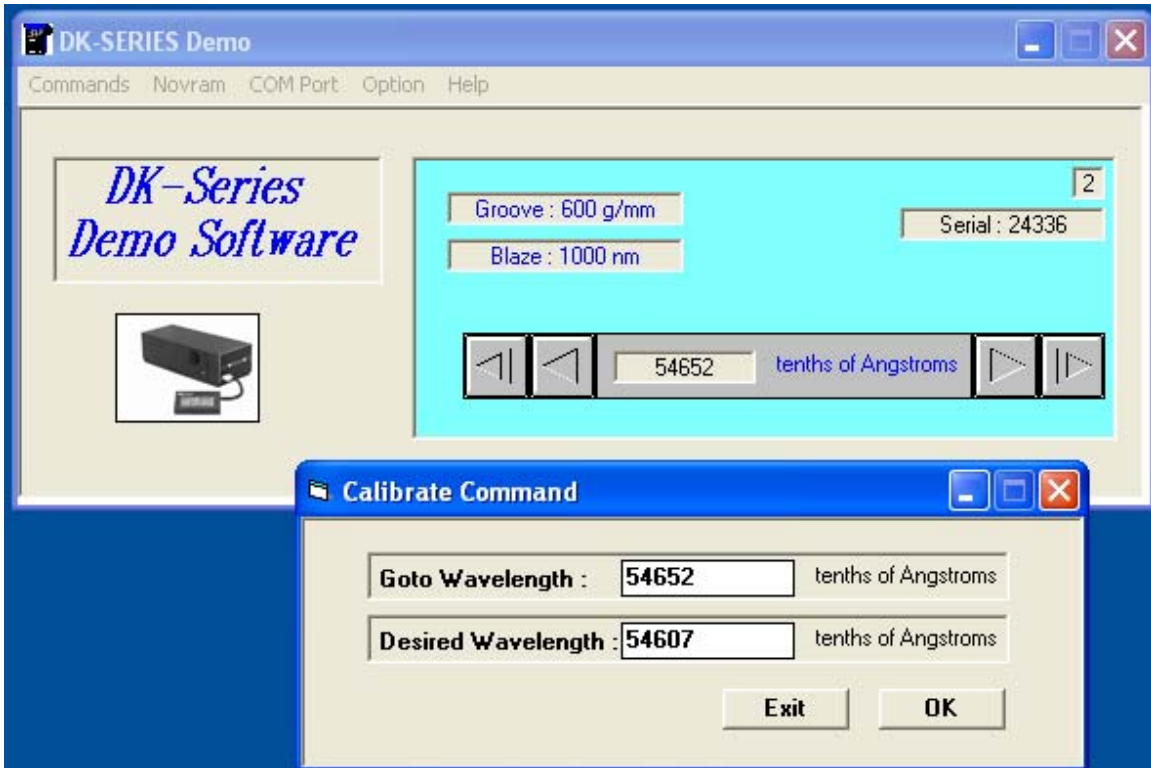

Spectral Products

2659-A Pan American Frwy., NE Albuquerque, NM 87107 Tel (505) 343-9700 Fax (505) 343-9705
www.spectralproducts.com

This page intentionally left blank.



Spectral Products

2659-A Pan American Frwy., NE Albuquerque, NM 87107 Tel (505) 343-9700 Fax (505) 343-9705
www.spectralproducts.com